



Folk Tables

Design by PearsonLloyd

Folk is both timeless in its seemingly familiar design, and timely in its modest and ingenious flexibility. A range of wood, plastic and aluminium finishes, different colors and upholstery options allow you

to change Folk’s flavour so that it can appear like a range of different chairs that somehow sit together harmoniously in one space.

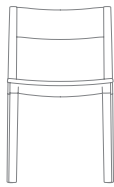

FLK100U3

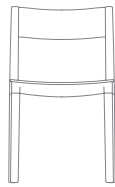

FLK101

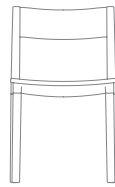

FLK101U1

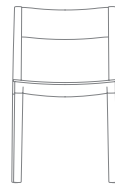

FLK103

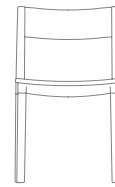

FLK103U1

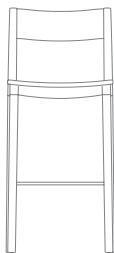

FLK300U3

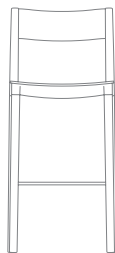

FLK301

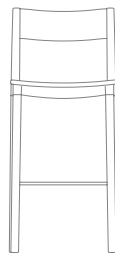

FLK301U1

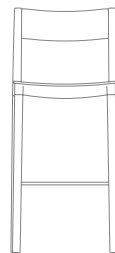

FLK303

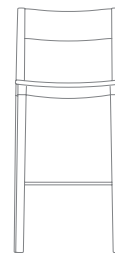

FLK303U1



Design  
PearsonLloyd

Luke Pearson and Tom Lloyd first met while studying Furniture Design and Industrial Design respectively, at London’s prestigious Royal College of Art. They set up their multi award winning design studio in 1997. Since then the studio has created stunning

solutions for a variety of international clients from the aviation, workplace, urban design and healthcare sectors identifying and responding to shifting patterns of behaviour in contemporary life.

**Standard Features**

- (\* - Selected models only)
- Beech ply seat with a clear finish\*
- Beech ply back with a clear finish\*
- Plastic seat - Color : Off-Black\*
- Plastic back - Color : Off-Black\*
- Upholstered seat\*
- Upholstered back\*
- Cast Aluminum frame
- Solid Beech legs
- Footrest\*
- Footrest protector\*
- Plastic glides
- Stacks up to 4 high\*

**Optional Features**

- (\* - Selected models only)
- Oak ply seat, back and solid Oak legs\*
- Oak ply back and solid Oak legs\*
- Solid Oak legs\*
- Plastic glides with felt

**Performance Standards**

- BS EN 16139:2013-Level1
- ANSI/BIFMA X5.1-2017
- Indoor Air Quality Certified to SCS-EC10.3-2014 v4.0

**Dimensions**

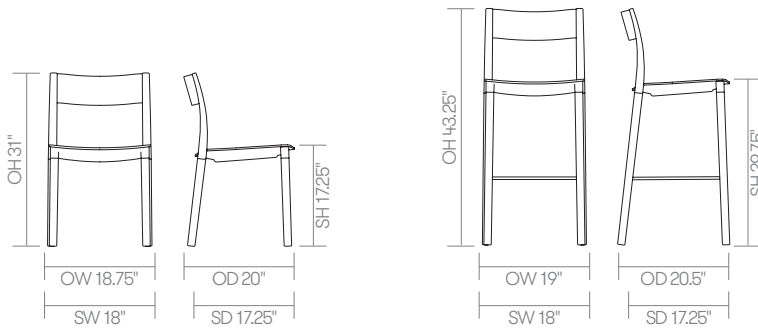

**Environmental Performance**

**Material Content**

Components are constructed of the following

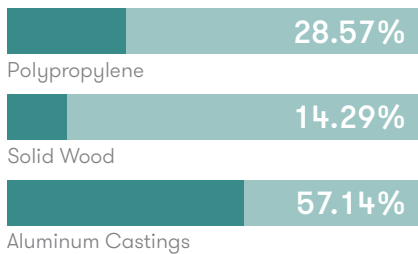

**Recycled Content**

Contains up to 57.00% of Recycled Material



**Recyclability**

The range is 99% recyclable

99%

### Finish Options

Beech seat, back and legs with a clear finish\*

Plastic seat and back available in a selection of Folk colors\*

Beech seat, back and legs available in a selection of Folk color washes or stained\*

Solid Oak legs available in a selection of Folk color washes or stained\*

Oak seat, back and legs with a clear finish\*

Cast Aluminium frame available in a selection of Folk colors

Seat and back can be upholstered in a broad range of contract upholstery fabrics, vinyls and leathers from Allermuir standard collection

### Frame and Plastic Finishes



Off-Black powder coat



White powder coat



Crayon Gray powder coat



Pistachio powder coat



Seattle Green powder coat



Aubergine powder coat

### Solid Wood Finishes



Clear Beech

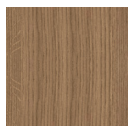

Clear Oak

### Colour Stains based on Beech



American Cherry

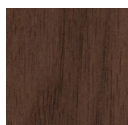

American Walnut

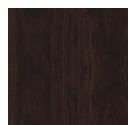

Dark Walnut

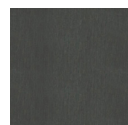

Wenge

### Colour Washes based on Beech



Off-Black powder coat



White powder coat



Crayon Gray powder coat



Pistachio powder coat



Seattle Green powder coat

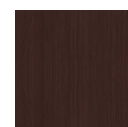

Aubergine powder coat

**Note:** Colour images are for reference only. Please verify with actual colour sample.

**Note:** We cannot offer the FLK100U3 and FLK300U3 in the following fabric ranges:

Camira - Craggan Flax  
Camira - Yoredale

Kvadrat - Coda 2  
Kvadrat - Hallingdal 65  
Kvadrat - Mosaic  
Kvadrat - Nitto