

# Offline Directory

## Everything you need in one place.

This Directory contains every piece of Allermuir product information you need to help you specify and order your desired product.

Should you want to know more simply scan the QR code to be taken to the product page on the Allermuir website where you can download, CAD, imagery and fabric approval sheet and price list.

## Chairs and Stools

06 – 57

Axyl <sup>08</sup> / Bastille <sup>14</sup> / Cardita <sup>15</sup>  
 Casper <sup>16</sup> / Crop <sup>20</sup> / Famiglia <sup>21</sup> / Folk <sup>26</sup>  
 Jojo <sup>30</sup> / Kin <sup>31</sup> / Mollie <sup>45</sup> / Ooty <sup>47</sup>  
 Phoulds <sup>48</sup> / Tommo <sup>54</sup>

## Soft Seating

58 – 97

Conic <sup>60</sup> / Famiglia <sup>62</sup> / Fifty Series <sup>67</sup>  
 Grainger <sup>70</sup> / Haven <sup>72</sup> / Haven Bench <sup>74</sup>  
 Jinx <sup>76</sup> / Lola <sup>77</sup> / Mayze Mobile <sup>79</sup>  
 Mozaik <sup>80</sup> / Open <sup>82</sup> / Pause <sup>84</sup>  
 Pebble <sup>87</sup> / Plum <sup>08</sup> / Qu <sup>92</sup> / Tarry <sup>93</sup>  
 Tylus & Cushions <sup>94</sup> / Venus <sup>96</sup>

## Sofas

98 – 113

Mayze <sup>100</sup> / Obris <sup>102</sup> / Orai <sup>103</sup>  
 Oran <sup>104</sup> / Paver <sup>106</sup> / Plum <sup>108</sup> / Stirling <sup>112</sup>

## Tables

114 – 147

Axyl <sup>116</sup> / Batan <sup>118</sup> / Cirque <sup>121</sup>  
 Conic <sup>123</sup> / Folk <sup>124</sup> / Folk Environmental <sup>125</sup>  
 FortySeven <sup>126</sup> / FortySeven XL <sup>132</sup> / Host <sup>135</sup>  
 Oran <sup>136</sup> / Pache <sup>137</sup> / Silta <sup>140</sup> / Sunda 1 <sup>142</sup>  
 Sunda 2 <sup>143</sup> / Tibo <sup>144</sup> / Turo <sup>145</sup>  
 Turo Environmental <sup>146</sup>

## Outdoor

148 – 155

Axyl Outdoor <sup>150</sup> / Crop Outdoor <sup>154</sup>  
 Tibo Outdoor <sup>155</sup>

## Storage

156 – 169

Crate Divide <sup>158</sup> / Crate <sup>166</sup> / Crate Caddy <sup>167</sup>  
 Furow <sup>168</sup> / Mozaik Storage <sup>169</sup>

## Finishes

170 – 189

## Resources

190 – 193

## Contents

008	Axyl
014	Bastille
015	Cardita
016	Casper
020	Crop
021	Famiglia
026	Folk
030	Jojo
031	Kin
045	Mollie
047	Ooty
048	Phoulds
054	Tommo

06

07

# Chairs and Stools

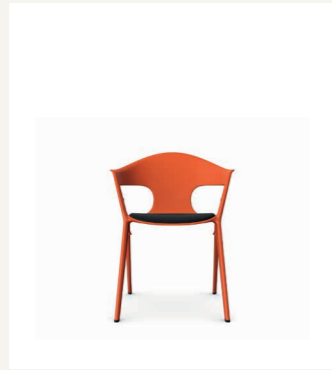
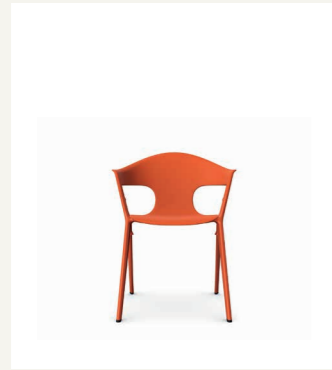

**AXYL - AXL02**  
Arm chair

Dimensions:

Seat Height	450mm
Seat Width	415mm
Seat Depth	435mm
Overall Height	780mm
Overall Width	605mm
Overall Depth	565mm

Standard Features:

- Plastic shell finished in Black
- Cast Aluminium frame finished in Matt Black powder coat
- Stacking buffers
- Plastic glides
- Stacks up to 4 high

Optional Features:

- Plastic shell with complementary Aluminium powder coat frame available in a selection of colours
- Wood fibre injected shell with complementary Aluminium frame
- Polished Aluminium frame
- Plastic glides with felt

Frame Finishes:

Matt Black	
Basalt	
Peacock Blue	
Sage	
Coral	
Matt White	
Pebble	
Stone	

Shell Finishes:

Black	
Basalt	
Peacock Blue	
Sage	
Coral	
White	
Pebble (Wood Fibre)	
Stone (Wood Fibre)	

For larger swatches go to pg.172-174

Additional frame finishes also available please go to pg.172 to see more.



**AXYL - AXL02U**  
Arm chair with upholstered seat pad

Dimensions:

Seat Height	450mm
Seat Width	415mm
Seat Depth	435mm
Overall Height	780mm
Overall Width	605mm
Overall Depth	565mm

Standard Features:

- Plastic shell finished in Black
- Upholstered seat pad
- Cast Aluminium frame finished in Matt Black powder coat
- Stacking buffers
- Plastic glides
- Stacks up to 4 high

Optional Features:

- Plastic shell with complementary Aluminium powder coat frame available in a selection of colours
- Wood fibre injected shell with complementary Aluminium frame
- Polished Aluminium frame
- Plastic glides with felt

Frame Finishes:

Matt Black	
Basalt	
Peacock Blue	
Sage	
Coral	
Matt White	
Pebble	
Stone	

Shell Finishes:

Black	
Basalt	
Peacock Blue	
Sage	
Coral	
White	
Pebble (Wood Fibre)	
Stone (Wood Fibre)	

For larger swatches go to pg.172-174

Additional frame finishes also available please go to pg.172 to see more.

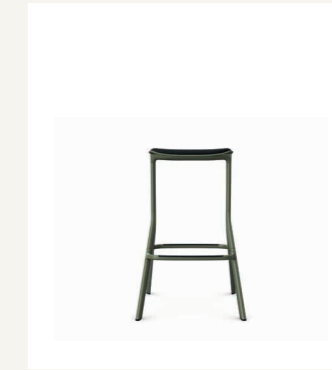

**Axyl - AXL04**  
High stool

Dimensions:

Seat Height	750mm
Seat Width	400mm
Seat Depth	385mm
Overall Height	750mm
Overall Width	495mm
Overall Depth	465mm

Standard Features:

- Plastic seat finished in Black
- Cast Aluminium frame finished in Matt Black powder coat
- Integral Plastic footrest protectors
- Plastic glides

Optional Features:

- Plastic seat with complementary Aluminium powder coat frame available in a selection of colours
- Wood fibre injected plastic seat with complementary Aluminium frame
- Raw or Polished Aluminium frame
- Plastic glides with felt

Frame Finishes:

Matt Black	
Basalt	
Peacock Blue	
Sage	
Coral	
Matt White	
Pebble	
Stone	

Shell Finishes:

Black	
Basalt	
Peacock Blue	
Sage	
Coral	
White	
Pebble (Wood Fibre)	
Stone (Wood Fibre)	

For larger swatches go to pg.172-174

Additional frame finishes also available please go to pg.172 to see more.



**Axyl - AXL04U**  
High stool with upholstered seat pad

Dimensions:

Seat Height	750mm
Seat Width	400mm
Seat Depth	385mm
Overall Height	750mm
Overall Width	495mm
Overall Depth	465mm

Standard Features:

- Plastic seat finished in Black
- Upholstered seat pad
- Cast Aluminium frame finished in Matt Black powder coat
- Integral Plastic footrest protectors
- Plastic glides

Optional Features:

- Plastic seat with complementary Aluminium powder coat frame available in a selection of colours
- Wood fibre injected plastic seat with complementary Aluminium frame
- Raw or Polished Aluminium frame
- Plastic glides with felt

Frame Finishes:

Matt Black	
Basalt	
Peacock Blue	
Sage	
Coral	
Matt White	
Pebble	
Stone	

Shell Finishes:

Black	
Basalt	
Peacock Blue	
Sage	
Coral	
White	
Pebble (Wood Fibre)	
Stone (Wood Fibre)	

For larger swatches go to pg.172-174

Additional frame finishes also available please go to pg.172 to see more.



↓ Scan here to discover more



↓ Scan here to discover more



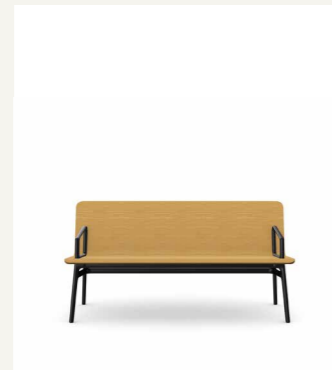
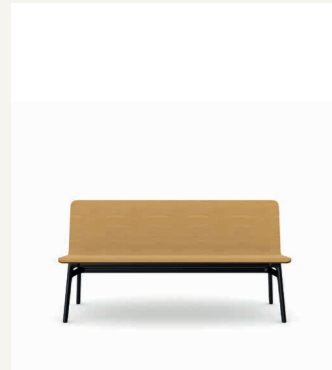

**Axyl Bench - AXLB16**  
Bench wood shell

Dimensions:  
 Seat Height 450mm  
 Seat Width 1600mm  
 Seat Depth 435mm  
 Overall Height 815mm  
 Overall Width 1600mm  
 Overall Depth 655mm

- Standard Features:
- Oak veneer ply shell with a clear finish
  - Cast Aluminium frame and extrusions finished in Matt Black powder coat
  - Plastic glides with levelling adjustment

- Optional Features:
- Cast Aluminium frame available in a selection of powder coat finishes
  - Oak veneer ply shell can be stained or colour washed to complement frame finish
  - Plastic glides with felt and levelling adjustment

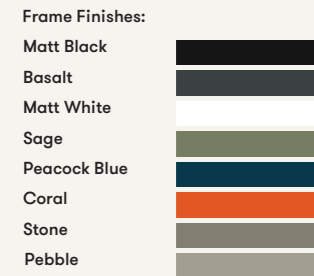

For larger swatches go to pg.172 and 176

6 optional Wood Stains and 8 colour washes based on Oak are also available please go to pg. 177 and 178 to see more.

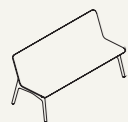

**Axyl Bench - AXLB16U2**  
Bench with arms and wood shell

Dimensions:  
 Seat Height 450mm  
 Seat Width 1410mm  
 Seat Depth 435mm  
 Arm Height 640mm  
 Overall Height 815mm  
 Overall Width 1600mm  
 Overall Depth 655mm

- Standard Features:
- Oak veneer ply shell with a clear finish
  - Cast Aluminium frame and extrusions finished in Matt Black powder coat
  - Cast Aluminium arms finished in Black powder coat
  - Plastic glides with levelling adjustment

- Optional Features:
- Cast Aluminium frame and arms available in a selection of powder coat finishes
  - Oak veneer ply shell can be stained or colour washed to complement frame finish
  - Plastic glides with felt and levelling adjustment

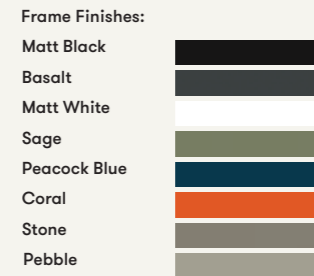

For larger swatches go to pg.172 and 176

6 optional Wood Stains and 8 colour washes based on Oak are also available please go to pg. 177 and 178 to see more.

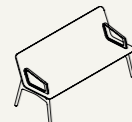

**Axyl Bench - AXLB16U3**  
Bench with upholstered inner shell

Dimensions:  
 Seat Height 435mm  
 Seat Width 1600mm  
 Seat Depth 435mm  
 Arm Height 640mm  
 Overall Height 815mm  
 Overall Width 1600mm  
 Overall Depth 655mm

- Standard Features:
- Upholstered inner shell and Oak veneer ply outer with a clear finish
  - Cast Aluminium frame and extrusions finished in Matt Black powder coat
  - Plastic glides with levelling adjustment

- Optional Features:
- Cast Aluminium frame available in a selection of powder coat finishes
  - Oak veneer ply shell can be stained or colour washed to complement frame finish
  - Plastic glides with felt and levelling adjustment

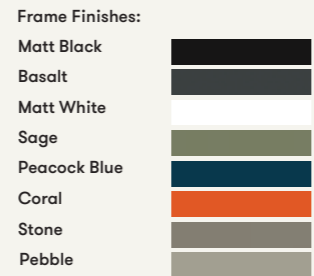

For larger swatches go to pg.172 and 176

6 optional Wood Stains and 8 colour washes based on Oak are also available please go to pg. 177 and 178 to see more.

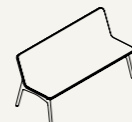

↓ Scan here to discover more

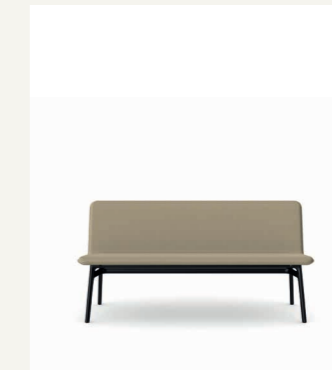

**Axyl Bench - AXLB16U2**  
Bench with arms, upholstered inner shell

Dimensions:  
 Seat Height 450mm  
 Seat Width 1410mm  
 Seat Depth 435mm  
 Arm Height 640mm  
 Overall Height 815mm  
 Overall Width 1600mm  
 Overall Depth 655mm

- Standard Features:
- Upholstered inner shell and Oak veneer ply outer with a clear finish
  - Cast Aluminium frame and extrusions finished in Matt Black powder coat
  - Cast Aluminium arms finished in Black powder coat
  - Plastic glides with levelling adjustment

- Optional Features:
- Cast Aluminium frame and arms available in a selection of powder coat finishes
  - Oak veneer ply shell can be stained or colour washed to complement frame finish
  - Plastic glides with felt and levelling adjustment

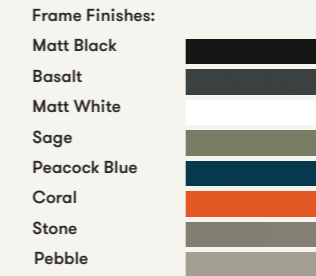

For larger swatches go to pg.172 and 176

6 optional Wood Stains and 8 colour washes based on Oak are also available please go to pg. 177 and 178 to see more.

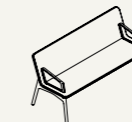

**Axyl Bench - AXLB16U3**  
Bench fully upholstered

Dimensions:  
 Seat Height 460mm  
 Seat Width 1375mm  
 Seat Depth 435mm  
 Overall Height 835mm  
 Overall Width 1640mm  
 Overall Depth 655mm

- Standard Features:
- Fully Upholstered shell
  - Cast Aluminium frame and extrusions finished in Matt Black powder coat
  - Plastic glides with levelling adjustment

- Optional Features:
- Cast Aluminium frame available in a selection of powder coat finishes
  - Plastic glides with felt and levelling adjustment

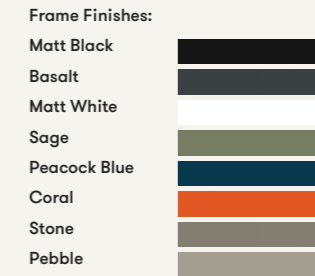

For larger swatches go to pg.172

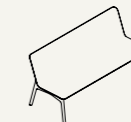

**Axyl Bench - AXLB16U3**  
Bench with arms, fully upholstered

Dimensions:  
 Seat Height 460mm  
 Seat Width 1375mm  
 Seat Depth 435mm  
 Arm Height 640mm  
 Overall Height 835mm  
 Overall Width 1640mm  
 Overall Depth 655mm

- Standard Features:
- Fully Upholstered shell
  - Cast Aluminium frame and extrusions finished in Matt Black powder coat
  - Fully Upholstered arms
  - Plastic glides with levelling adjustment

- Optional Features:
- Cast Aluminium frame available in a selection of powder coat finishes
  - Plastic glides with felt and levelling adjustment

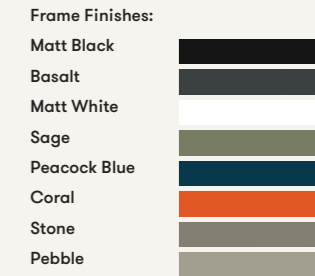

For larger swatches go to pg.172

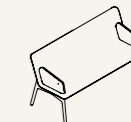

↓ Scan here to discover more





**Axyl Bench - AXLB20**  
Bench wood shell

Dimensions:  
 Seat Height 450mm  
 Seat Width 2000mm  
 Seat Depth 435mm  
 Overall Height 815mm  
 Overall Width 2000mm  
 Overall Depth 655mm

**Standard Features:**

- Oak veneer ply shell with a clear finish
- Cast Aluminium frame and extrusions finished in Matt Black powder coat
- Plastic glides with levelling adjustment

**Optional Features:**

- Cast Aluminium frame available in a selection of powder coat finishes
- Oak veneer ply shell can be stained or colour washed to complement frame finish
- Plastic glides with felt and levelling adjustment

**Frame Finishes:**

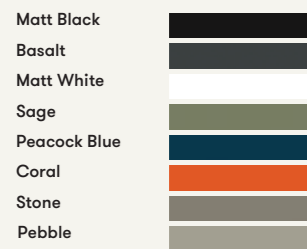

**Veneer:**



For larger swatches go to pg.172 and 176

6 optional Wood Stains and 8 colour washes based on Oak are also available please go to pg. 177 and 178 to see more.

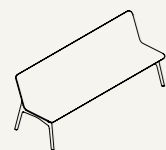

**Axyl Bench - AXLBA20**  
Bench with arms and wood shell

Dimensions:  
 Seat Height 450mm  
 Seat Width 1810mm  
 Seat Depth 435mm  
 Arm Height 640mm  
 Overall Height 815mm  
 Overall Width 2000mm  
 Overall Depth 655mm

**Standard Features:**

- Oak veneer ply shell with a clear finish
- Cast Aluminium frame and extrusions finished in Matt Black powder coat
- Cast Aluminium arms finished in Black powder coat
- Plastic glides with levelling adjustment

**Optional Features:**

- Cast Aluminium frame and arms available in a selection of powder coat finishes
- Oak veneer ply shell can be stained or colour washed to complement frame finish
- Plastic glides with felt and levelling adjustment

**Frame Finishes:**

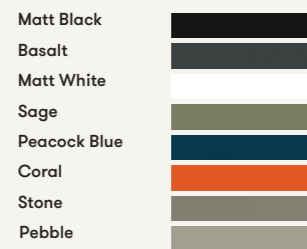

**Veneer:**



For larger swatches go to pg.172 and 176

6 optional Wood Stains and 8 colour washes based on Oak are also available please go to pg. 177 and 178 to see more.

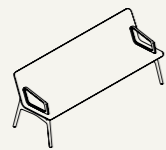

**Axyl Bench - AXLB20U2**  
Bench with upholstered inner shell

Dimensions:  
 Seat Height 450mm  
 Seat Width 2000mm  
 Seat Depth 435mm  
 Arm Height 640mm  
 Overall Height 815mm  
 Overall Width 2000mm  
 Overall Depth 655mm

**Standard Features:**

- Upholstered inner shell and Oak veneer ply outer with a clear finish
- Cast Aluminium frame and extrusions finished in Matt Black powder coat
- Plastic glides with levelling adjustment

**Optional Features:**

- Cast Aluminium frame available in a selection of powder coat finishes
- Oak veneer ply shell can be stained or colour washed to complement frame finish
- Plastic glides with felt and levelling adjustment

**Frame Finishes:**

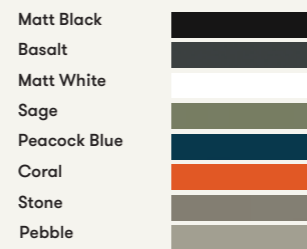

**Veneer:**

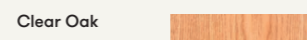

For larger swatches go to pg.172 and 176

6 optional Wood Stains and 8 colour washes based on Oak are also available please go to pg. 177 and 178 to see more.

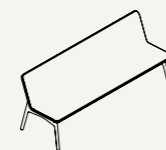

↓ Scan here to discover more



**Axyl Bench - AXLBA20U2**  
Bench with arms, upholstered inner shell

Dimensions:  
 Seat Height 450mm  
 Seat Width 1810mm  
 Seat Depth 435mm  
 Arm Height 640mm  
 Overall Height 815mm  
 Overall Width 2000mm  
 Overall Depth 655mm

**Standard Features:**

- Upholstered inner shell and Oak veneer ply outer with a clear finish
- Cast Aluminium frame and extrusions finished in Matt Black powder coat
- Cast Aluminium arms finished in Black powder coat
- Plastic glides with leveling adjustment

**Optional Features:**

- Cast Aluminium frame and arms available in a selection of powder coat finishes
- Oak veneer ply shell can be stained or colour washed to complement frame finish
- Plastic glides with felt and levelling adjustment

**Frame Finishes:**

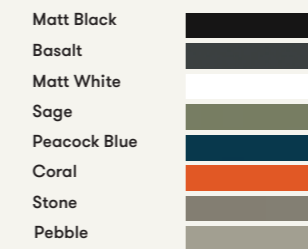

**Veneer:**

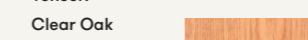

For larger swatches go to pg.172 and 176

6 optional Wood Stains and 8 colour washes based on Oak are also available please go to pg. 177 and 178 to see more.

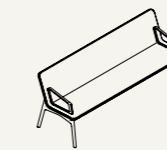

**Axyl Bench - AXLB20U3**  
Bench fully upholstered

Dimensions:  
 Seat Height 460mm  
 Seat Width 1775mm  
 Seat Depth 435mm  
 Overall Height 835mm  
 Overall Width 2040mm  
 Overall Depth 655mm

**Standard Features:**

- Fully Upholstered shell
- Cast Aluminium frame and extrusions finished in Matt Black powder coat
- Plastic glides with leveling adjustment

**Optional Features:**

- Cast Aluminium frame available in a selection of powder coat finishes
- Plastic glides with felt and leveling adjustment

**Frame Finishes:**

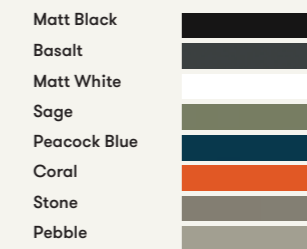

For larger swatches go to pg.172

**Axyl Bench - AXLBA20U3**  
Bench with arms, fully upholstered

Dimensions:  
 Seat Height 460mm  
 Seat Width 1775mm  
 Seat Depth 435mm  
 Arm Height 640mm  
 Overall Height 835mm  
 Overall Width 2040mm  
 Overall Depth 655mm

**Standard Features:**

- Fully Upholstered shell
- Cast Aluminium frame and extrusions finished in Matt Black powder coat
- Fully Upholstered arms
- Plastic glides with leveling adjustment

**Optional Features:**

- Cast Aluminium frame available in a selection of powder coat finishes
- Plastic glides with felt and leveling adjustment

**Frame Finishes:**

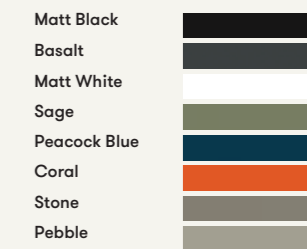

For larger swatches go to pg.172

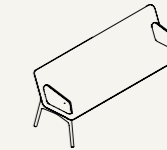

↓ Scan here to discover more

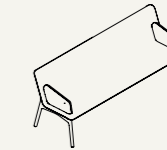
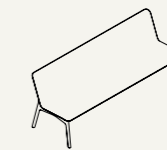
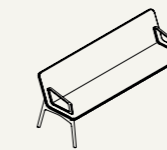

# Bastille

Design by Patrick Norguet

14

15

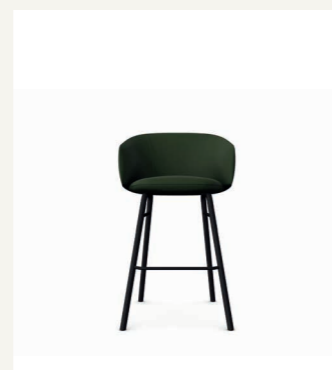
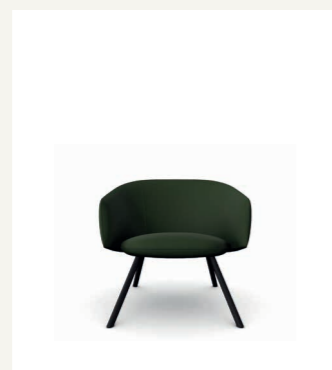
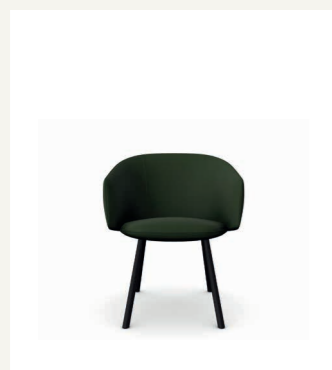

## Bastille - BST01 Dining Chair

Dimensions:  
 Seat Height 470mm  
 Seat Width 455mm  
 Seat Depth 460mm  
 Overall Height 780mm  
 Overall Width 630mm  
 Overall Depth 590mm

- Standard Features:
- Moulded foam construction
  - Fully upholstered with perimeter piping
  - Tubular Steel frame finished in New Black powder coat
  - Plastic glides

- Optional Features:
- Tubular Steel frame available in a selection of powder coat finishes
  - Plastic glides with felt

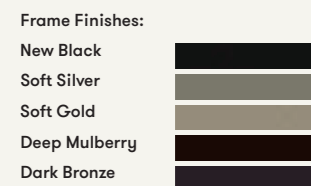

For larger swatches go to pg.172-173

## Bastille - BST03 Lounge Chair

Dimensions:  
 Seat Height 405mm  
 Seat Width 555mm  
 Seat Depth 510mm  
 Overall Height 670mm  
 Overall Width 745mm  
 Overall Depth 705mm

- Standard Features:
- Moulded foam construction
  - Fully upholstered with perimeter piping
  - Tubular Steel frame finished in New Black powder coat
  - Plastic glides

- Optional Features:
- Tubular Steel frame available in a selection of powder coat finishes
  - Plastic glides with felt

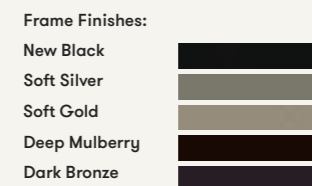

For larger swatches go to pg.172-173

## Bastille - BST05 Bar Stool

Dimensions:  
 Seat Height 750mm  
 Seat Width 450mm  
 Seat Depth 430mm  
 Overall Height 1005mm  
 Overall Width 610mm  
 Overall Depth 610mm

- Standard Features:
- Moulded foam construction
  - Fully upholstered with perimeter piping
  - Tubular Steel frame finished in New Black powder coat
  - Footrest protector
  - Plastic glides

- Optional Features:
- Tubular Steel frame available in a selection of powder coat finishes
  - Plastic glides with felt
  - Counter height stool option, seat height 655mm (add CH to product code)

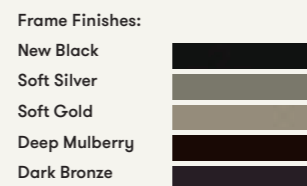

For larger swatches go to pg.172-173



↓ Scan here to discover more



↓ Scan here to discover more



# Cardita

Design by Martin Ballendat



## Cardita - CRD01 Side chair

Dimensions:  
 Seat Height 440mm  
 Seat Width 480mm  
 Seat Depth 440mm  
 Overall Height 830mm  
 Overall Width 550mm  
 Overall Depth 625mm

- Standard Features:
- Moulded Foam shell
  - Fully upholstered with luxury quilt detail
  - Solid Ash legs with a clear finish
  - Plastic glides

- Optional Features:
- Solid Ash legs can be stained or colour washed
  - Plastic glides with felt



For larger swatches go to pg.177

16 optional standard colour washes based on Ash are also available please go to pg.178 to see more.



## Cardita - CRD03 Stool

Dimensions:  
 Seat Height 730mm  
 Seat Width 435mm  
 Seat Depth 370mm  
 Overall Height 1010mm  
 Overall Width 500mm  
 Overall Depth 515mm

- Standard Features:
- Moulded Foam shell
  - Fully upholstered with luxury quilt detail
  - Solid Ash legs with a clear finish
  - Tubular Steel footrest finished in Polished Chrome
  - Plastic glides

- Optional Features:
- Solid Ash legs can be stained or colour washed
  - Plastic glides with felt
  - Counter height stool option, seat height 625mm

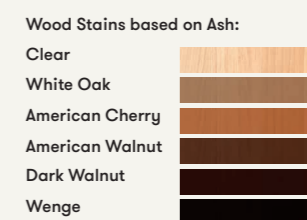

Footrest Finish:  
 Polished Chrome

For larger swatches go to pg.173-177

16 optional standard colour washes based on Ash are also available please go to pg.178 to see more.



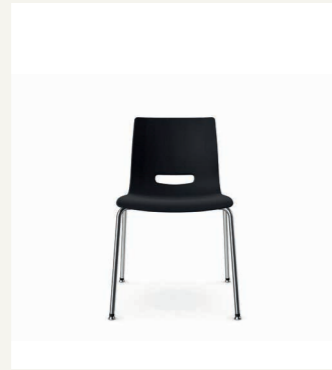
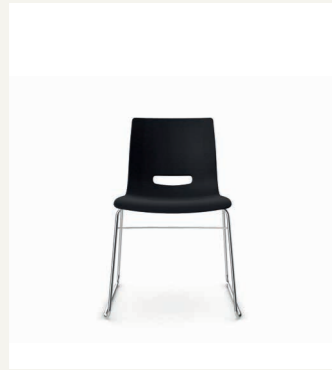

**Casper - CS1**  
Side chair on a skid frame

Dimensions:  
 Seat Height 470mm  
 Seat Width 460mm  
 Seat Depth 440mm  
 Overall Height 815mm  
 Overall Width 560mm  
 Overall Depth 550mm

- Standard Features:**
- Plastic shell available in a selection of colours
  - Plastic underseat stack pan
  - Wire frame finished in Polished Chrome
  - Plastic glides
  - Stacks (on trolley) up to 25 high

- Optional Features:**
- Detachable writing tablet
  - Plastic linking glides
  - Plastic glides with felt
  - Chair trolley (CF Trolley): MX1005BL

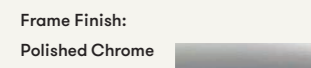
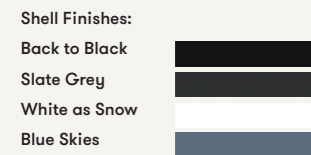

For larger swatches go to pg.172-174

**Casper - CS2**  
Side chair on a 4 leg frame

Dimensions:  
 Seat Height 470mm  
 Seat Width 460mm  
 Seat Depth 440mm  
 Overall Height 815mm  
 Overall Width 550mm  
 Overall Depth 550mm

- Standard Features:**
- Plastic shell available in a selection of colours
  - Plastic underseat stack pan
  - Tubular steel frame finished in Polished Chrome
  - Plastic self-levelling glides
  - Stacks (on trolley) up to 18 high

- Optional Features:**
- Plastic steel self-levelling glides with felt
  - Chair trolley (CF Trolley): MX1005BL

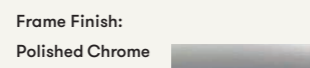
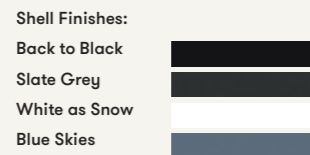

For larger swatches go to pg.172-174



↓ Scan here to discover more



↓ Scan here to discover more

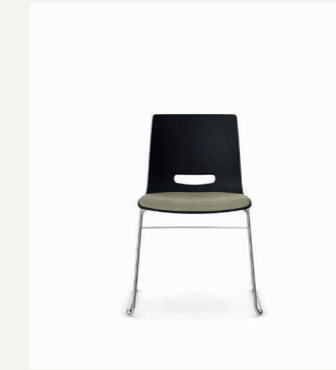

**Casper - CS3**  
Side chair on a skid frame with upholstered seat pad

Dimensions:  
 Seat Height 470mm  
 Seat Width 460mm  
 Seat Depth 440mm  
 Overall Height 815mm  
 Overall Width 560mm  
 Overall Depth 550mm

- Standard Features:**
- Plastic shell available in a selection of colours
  - Plastic underseat stack pan
  - Wire frame finished in Polished Chrome
  - Plastic glides
  - Upholstered seat pad

- Optional Features:**
- Detachable writing tablet
  - Plastic linking glides
  - Plastic glides with felt
  - Ribbed upholstered seat pad (add P to product code)

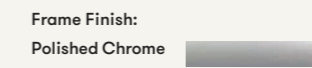

For larger swatches go to pg.172-174

**Casper - CS4**  
Side chair on a 4 leg frame with upholstered seat pad

Dimensions:  
 Seat Height 470mm  
 Seat Width 460mm  
 Seat Depth 440mm  
 Overall Height 815mm  
 Overall Width 550mm  
 Overall Depth 550mm

- Standard Features:**
- Plastic shell available in a selection of colours
  - Plastic underseat stack pan
  - Tubular steel frame finished in Polished Chrome
  - Plastic self-levelling glides
  - Upholstered seat pad

- Optional Features:**
- Plastic self-levelling glides with felt
  - Ribbed upholstered seat pad (add P to product code)

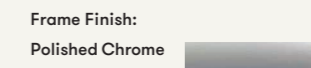

For larger swatches go to pg.172-174



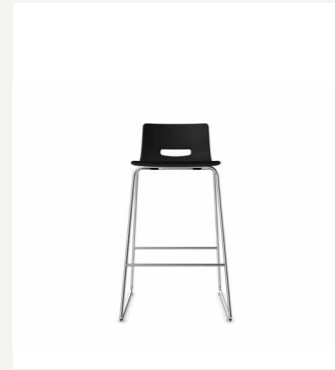
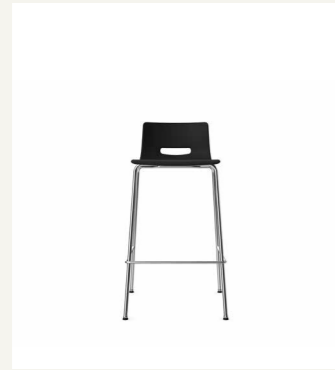

**Casper - CS5BS**  
High stool on a 4 leg frame

Dimensions:

Seat Height	760mm
Seat Width	415mm
Seat Depth	420mm
Overall Height	960mm
Overall Width	530mm
Overall Depth	520mm

Standard Features:

- Plastic shell available in a selection of colours
- Tubular steel frame finished in Polished Chrome
- Plastic self-levelling glides

Optional Features:

- Plastic self-levelling glides with felt
- Counter height stool option, seat height 625mm (add CH to product code)

Shell Finishes:

Back to Black	
Slate Grey	
White as Snow	
Blue Skies	

Frame Finish:

Polished Chrome	
-----------------	--

For larger swatches go to pg.172-174

**Casper - CS9BS**  
High stool on a skid frame

Dimensions:

Seat Height	760mm
Seat Width	415mm
Seat Depth	420mm
Overall Height	960mm
Overall Width	530mm
Overall Depth	520mm

Standard Features:

- Plastic shell available in a selection of colours
- Wire frame finished in Polished Chrome
- Plastic glides

Optional Features:

- Ribbed upholstered seat pad
- Plastic glides with felt
- Counter height stool option, seat height 625mm (add CH to product code)

Shell Finishes:

Back to Black	
Slate Grey	
White as Snow	
Blue Skies	

Frame Finish:

Polished Chrome	
-----------------	--

For larger swatches go to pg.172-174



↓ Scan here to discover more



↓ Scan here to discover more

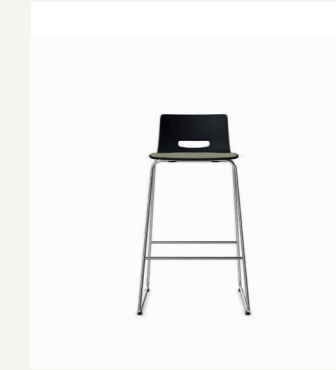
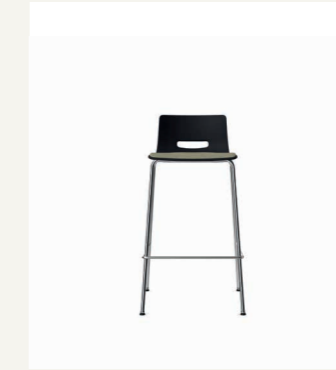

**Casper - CS6BS**  
High stool on a 4 leg frame with upholstered seat pad

Dimensions:

Seat Height	760mm
Seat Width	415mm
Seat Depth	420mm
Overall Height	960mm
Overall Width	530mm
Overall Depth	520mm

Standard Features:

- Plastic shell available in a selection of colours
- Tubular steel frame finished in Polished Chrome
- Plastic self-levelling glides

Optional Features:

- Plastic self-levelling glides with felt
- Counter height stool option, seat height 625mm (add CH to product code)

Shell Finishes:

Back to Black	
Slate Grey	
White as Snow	
Blue Skies	

Frame Finish:

Polished Chrome	
-----------------	--

For larger swatches go to pg.172-174

**Casper - CS10BS**  
High stool on a skid frame with upholstered seat pad

Dimensions:

Seat Height	760mm
Seat Width	415mm
Seat Depth	420mm
Overall Height	960mm
Overall Width	530mm
Overall Depth	520mm

Standard Features:

- Plastic shell available in a selection of colours
- Wire frame finished in Polished Chrome
- Plastic glides

Optional Features:

- Ribbed upholstered seat pad
- Plastic glides with felt
- Counter height stool option, seat height 625mm (add CH to product code)

Shell Finishes:

Back to Black	
Slate Grey	
White as Snow	
Blue Skies	

Frame Finish:

Polished Chrome	
-----------------	--

For larger swatches go to pg.172-174



# Crop

Design by Benjamin Hubert | Layer

20

21

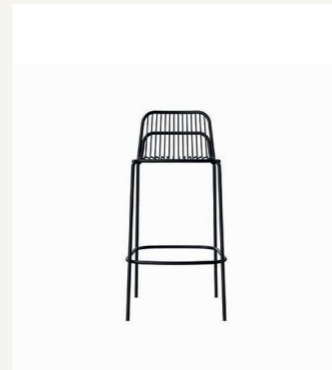
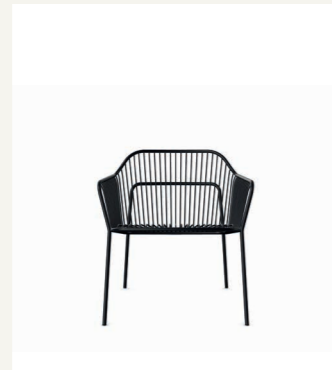

Crop - CRP02  
Armchair

Dimensions:  
 Seat Height 480mm  
 Seat Width 490mm  
 Seat Depth 435mm  
 Overall Height 835mm  
 Overall Width 620mm  
 Overall Depth 555mm

- Standard Features:
- Steel wire frame finished in Black (Textured) powder coat for outdoor use
  - Plastic stacking buffers
  - Plastic glides
  - Stacks up to 4 high

- Optional Features:
- Steel wire frame available in a selection of powder coat finishes

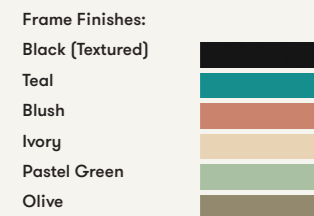

For larger swatches go to pg.172-186



Crop - CRP03  
Lounge chair

Dimensions:  
 Seat Height 420mm  
 Seat Width 510mm  
 Seat Depth 490mm  
 Overall Height 730mm  
 Overall Width 675mm  
 Overall Depth 675mm

- Standard Features:
- Steel wire frame finished in Black (Textured) powder coat for outdoor use
  - Plastic glides

- Optional Features:
- Steel wire frame available in a selection of powder coat finishes

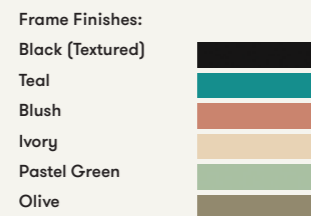

For larger swatches go to pg.172-186



Crop - CRP05  
High back stool

Dimensions:  
 Seat Height 780mm  
 Seat Width 425mm  
 Seat Depth 390mm  
 Overall Height 1015mm  
 Overall Width 475mm  
 Overall Depth 505mm

- Standard Features:
- Steel wire frame finished in Black (Textured) powder coat for outdoor use
  - Plastic glides

- Optional Features:
- Steel wire frame available in a selection of powder coat finishes
  - Counter height stool option, seat height 625mm (add CH to product code)

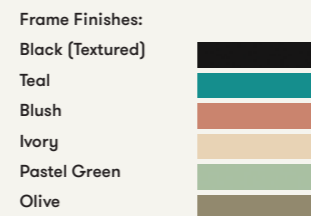

For larger swatches go to pg.172-186



# Famiglia

Design by Pearson Lloyd



Famiglia - FMG-1101  
Low back on a 4 leg frame with casters

Dimensions:  
 Seat Height 475mm  
 Seat Width 450mm  
 Seat Depth 450mm  
 Overall Height 820mm  
 Overall Width 640mm  
 Overall Depth 595mm

- Standard Features:
- Moulded foam construction
  - Fully Upholstered
  - Tubular Steel Frame on 50mm hard wheel casters finished in New Black powder coat
  - 50mm hard wheel casters

- Optional Features:
- Tubular Steel frame available in a selection of powder coat finishes
  - 50mm soft wheels casters
  - Multi-Fabrics



For larger swatches go to pg.172-173



Famiglia - FMG-1102  
Low back chair on a 4 leg frame

Dimensions:  
 Seat Height 450mm  
 Seat Width 450mm  
 Seat Depth 450mm  
 Overall Height 795mm  
 Overall Width 640mm  
 Overall Depth 595mm

- Standard Features:
- Moulded foam construction
  - Fully Upholstered
  - Tubular Steel Frame finished in New Black powder coat
  - Plastic Glides

- Optional Features:
- Tubular Steel frame available in a selection of powder coat finishes
  - Plastic Glides with felt
  - Multi-Fabrics



For larger swatches go to pg.172-173



Famiglia - FMG-1103  
Low back chair on wood legs

Dimensions:  
 Seat Height 455mm  
 Seat Width 450mm  
 Seat Depth 450mm  
 Overall Height 805mm  
 Overall Width 640mm  
 Overall Depth 595mm

- Standard Features:
- Moulded foam construction
  - Fully Upholstered
  - Aluminium leg connector frame finished in New Black powder coat
  - Solid Ash legs with a clear finish
  - Plastic Glides

- Optional Features:
- Solid Ash legs can be stained or colour washed
  - Plastic Glides with felt
  - Multi-Fabrics



For larger swatches go to pg.172-177

16 optional standard colour washes based on Ash are also available please go to pg.193 to see more.



↓ Scan here to discover more



↓ Scan here to discover more



# Famiglia

Design by Pearson Lloyd

22

23

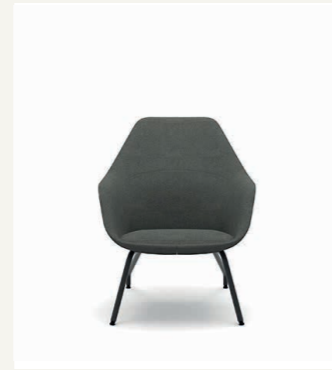

**Famiglia - FMG1105**  
Low back chair on 4 star base glides

Dimensions:

Seat Height	465mm
Seat Width	450mm
Seat Depth	450mm
Overall Height	810mm
Overall Width	640mm
Overall Depth	595mm

- Standard Features:
- Moulded foam construction
  - Fully Upholstered
  - 4 star Aluminium swivel base on glides finished in New Black powder coat
  - Plastic Glides

- Optional Features:
- Aluminium base available in a selection of powder coat finishes
  - 4 star auto return base on glides
  - Plastic Glides with felt
  - Multi-Fabrics

Frame Finishes:

New Black	
White	
Soft Gold	
Soft Silver	
Dark Bronze	
Deep Mulberry	

For larger swatches go to pg.172-173

**Famiglia - FMG1106**  
Low back chair on a 5 star base with casters

Dimensions:

Seat Height	515mm
Seat Width	450mm
Seat Depth	450mm
Overall Height	860mm
Overall Width	650mm
Overall Depth	595mm

- Standard Features:
- Moulded foam construction
  - Fully Upholstered
  - 5 star Aluminium swivel base with height adjustment on 50mm hard wheel casters finished in New Black powder coat

- Optional Features:
- Aluminium base available in a selection of powder coat finishes
  - 50mm soft wheel casters
  - Multi-Fabrics

Frame Finishes:

New Black	
White	
Soft Gold	
Soft Silver	
Dark Bronze	
Deep Mulberry	

For larger swatches go to pg.172-173

**Famiglia - FMG1201**  
Mid back on a recliner frame

Dimensions:

Seat Height	390mm
Seat Width	485mm
Seat Depth	485mm
Overall Height	835mm
Overall Width	720mm
Overall Depth	665mm

- Standard Features:
- Moulded foam construction with dual density back foam
  - Fully Upholstered
  - Tubular Steel reclined frame finished in New Black powder coat
  - Plastic Glides

- Optional Features:
- Tubular Steel frame available in a selection of powder coat finishes
  - Plastic Glides with felt
  - Multi-Fabrics

Frame Finishes:

New Black	
White	
Soft Gold	
Soft Silver	
Dark Bronze	
Deep Mulberry	

For larger swatches go to pg.172-173



↓ Scan here to discover more



↓ Scan here to discover more



# Famiglia

Design by Pearson Lloyd

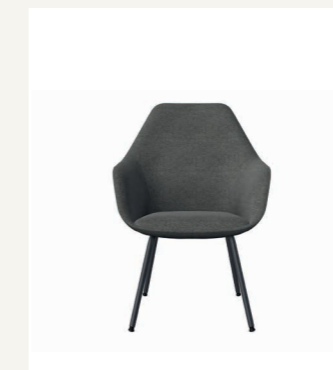

**Famiglia - FMG1202**  
Mid back chair on a 4 leg frame

Dimensions:

Seat Height	470mm
Seat Width	490mm
Seat Depth	470mm
Overall Height	980mm
Overall Width	665mm
Overall Depth	665mm

- Standard Features:
- Moulded foam construction with dual density back foam
  - Fully Upholstered
  - Tubular Steel frame finished in New Black powder coat
  - Plastic Glides

- Optional Features:
- Tubular Steel frame available in a selection of powder coat finishes
  - Plastic Glides with felt
  - Multi-Fabrics

Frame Finishes:

New Black	
White	
Soft Gold	
Soft Silver	
Dark Bronze	
Deep Mulberry	

For larger swatches go to pg.172-173

**Famiglia - FMG1203**  
Mid back chair on wood legs

Dimensions:

Seat Height	375mm
Seat Width	470mm
Seat Depth	475mm
Overall Height	815mm
Overall Width	665mm
Overall Depth	730mm

- Standard Features:
- Moulded foam construction with dual density back foam
  - Fully Upholstered
  - Solid Ash legs with a clear finish
  - Plastic Glides

- Optional Features:
- Solid Ash legs can be stained or colour washed
  - Plastic Glides with felt
  - Multi-Fabrics

Wood Stains based on Ash:

Clear	
White Oak	
American Cherry	
American Walnut	
Dark Walnut	
Wenge	

For larger swatches go to pg.177

16 optional standard colour washes based on Ash are also available please go to pg.193 to see more.

**Famiglia - FMG1206**  
Mid back chair on a 5 star base with casters

Dimensions:

Seat Height	505mm
Seat Width	470mm
Seat Depth	490mm
Overall Height	1010mm
Overall Width	710mm
Overall Depth	680mm

- Standard Features:
- Moulded foam construction with dual density back foam
  - Fully Upholstered
  - 5 star plastic base finished in Black
  - Dynamic free-floating recline and forward tilt with height adjustment
  - 65mm hard wheel casters

- Optional Features:
- 5 star Aluminium swivel base in Polished Aluminium
  - 65mm soft wheel casters
  - Multi-Fabrics

Frame Finishes:

Black Plastic	
Polished Aluminium	

For larger swatches go to pg.172-173



# Famiglia

Design by Pearson Lloyd

24

25



Famiglia - FMG1401  
Lounge Chair on wire frame

Dimensions:  
Seat Height 415mm  
Seat Width 545mm  
Seat Depth 560mm  
Overall Height 1090mm  
Overall Width 880mm  
Overall Depth 850mm

- Standard Features:
- Moulded foam construction with dual density back foam
  - Fully Upholstered
  - Tubular Steel frame finished in New Black powder coat
  - Plastic glides

- Optional Features:
- Tubular Steel frame available in a selection of powder coat finishes
  - Plastic Glides with felt
  - Multi-Fabrics

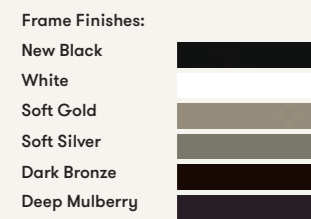

For larger swatches go to pg.172-173

Famiglia - FMG1403  
Lounge Chair on wooden frame

Dimensions:  
Seat Height 410mm  
Seat Width 545mm  
Seat Depth 560mm  
Overall Height 1080mm  
Overall Width 880mm  
Overall Depth 850mm

- Standard Features:
- Moulded foam construction with dual density back foam
  - Fully Upholstered
  - Solid Ash legs with a clear finish
  - Plastic glides

- Optional Features:
- Solid Ash legs can be stained or colour washed
  - Plastic Glides with felt
  - Multi-Fabrics

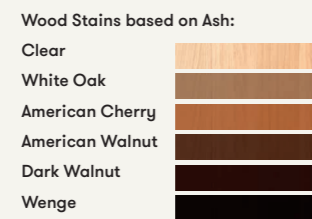

For larger swatches go to pg.177

16 optional standard colour washes based on Ash are also available please go to pg.178 to see more.

Famiglia - FMG1405  
Lounge chair on a 4 star swivel base

Dimensions:  
Seat Height 425mm  
Seat Width 545mm  
Seat Depth 560mm  
Overall Height 1100mm  
Overall Width 880mm  
Overall Depth 910mm

- Standard Features:
- Moulded foam construction with dual density back foam
  - Fully Upholstered
  - 4 Star Aluminium auto return swivel base in New Black powder coat
  - Plastic glides

- Optional Features:
- 4 Star Aluminium auto return swivel available in a selection of powder coat finishes
  - 4 Star Aluminium auto return swivel available in Polished Aluminium
  - Multi-Fabrics

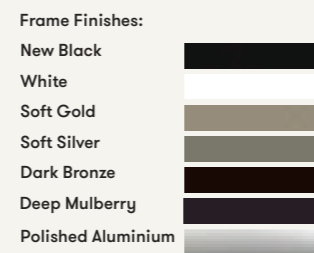

For larger swatches go to pg.172-173



↓ Scan here to discover more



↓ Scan here to discover more



# Famiglia

Design by Pearson Lloyd

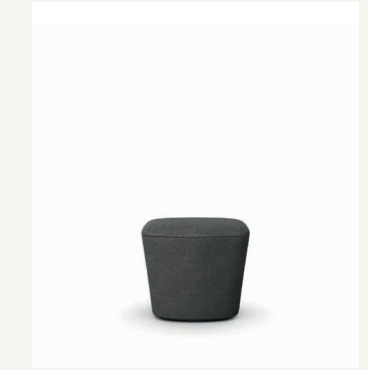

Famiglia - FMG1501  
High back on reclining frame

Dimensions:  
Seat Height 400mm  
Seat Width 495mm  
Seat Depth 530mm  
Overall Height 1175mm  
Overall Width 1175mm  
Overall Depth 830mm

- Standard Features:
- Moulded foam construction with dual density back foam
  - Fully Upholstered
  - Tubular Steel reclined frame finished in New Black powder coat
  - Plastic Glides

- Optional Features:
- Tubular Steel frame available in a selection of powder coat finishes
  - Plastic glides with felt
  - Multi-Fabrics

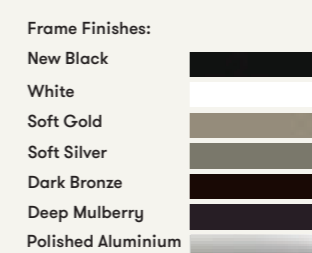

For larger swatches go to pg.172-173

Famiglia - FMG1505  
High back on 4 star swivel base

Dimensions:  
Seat Height 410mm  
Seat Width 495mm  
Seat Depth 530mm  
Overall Height 1195mm  
Overall Width 865mm  
Overall Depth 895mm

- Standard Features:
- Moulded foam construction with dual density back foam
  - Fully Upholstered
  - 4 star Aluminium auto return swivel base finished in New Black powder coat
  - Plastic Glides

- Optional Features:
- 4 star Aluminium auto return swivel base available in a selection of powder coat finishes.
  - 4 star Aluminium auto return swivel base available in Polished Aluminium
  - Multi-Fabrics

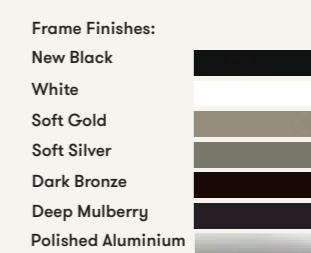

For larger swatches go to pg.172-173

Famiglia - FMGFS  
Footstool

Dimensions:  
Seat Height 430mm  
Seat Width 510mm  
Seat Depth 440mm  
Overall Height 430mm  
Overall Width 510mm  
Overall Depth 440mm

- Standard Features:
- Moulded foam construction
  - Fully Upholstered

- Optional Features:
- Multi-Fabrics



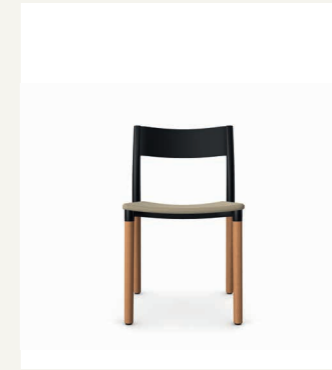
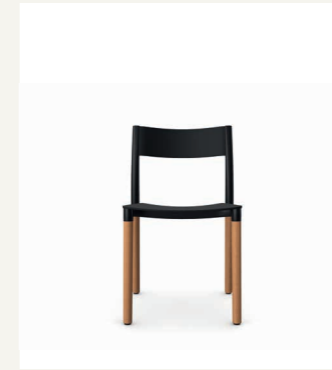
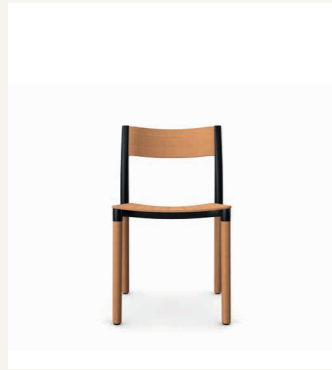

**Folk - FLK101**  
Chair with wood seat and back

Dimensions:

Seat Height	440mm
Seat Width	455mm
Seat Depth	435mm
Overall Height	790mm
Overall Width	475mm
Overall Depth	505mm

- Standard Features:
- Cast Aluminium frame in Off Black powder coat with Beech ply seat, back and legs in a clear finish
  - Plastic glides
  - Stacks up to 4 high

- Optional Features:
- Cast Aluminium frame available in a selection of powder coat finishes
  - Beech ply seat, back and solid Beech legs can be stained or colour washed
  - Oak ply seat, back and solid Oak legs with a clear finish
  - Plastic glides with felt

Frame Finishes:

Off Black	
White	
Crayon Grey	
Pistachio	
Seattle Green	
Aubergine	

Solid Wood Finishes:

Clear on Beech	
Clear on Oak	

For larger swatches go to pg.172-176

6 optional Wood Stains and 8 colour washes based on Beech are also available please go to pg.177 and 178 to see more.

**Folk - FLK101U1**  
Chair with wood back and upholstered seat

Dimensions:

Seat Height	440mm
Seat Width	455mm
Seat Depth	435mm
Overall Height	790mm
Overall Width	475mm
Overall Depth	505mm

- Standard Features:
- Upholstered seat
  - Cast Aluminium frame in Off Black powder coat with Beech ply back and legs in a clear finish
  - Plastic glides
  - Stacks up to 4 high

- Optional Features:
- Cast Aluminium frame available in a selection of powder coat finishes
  - Beech ply back and solid Beech legs can be stained or colour washed
  - Oak ply back and solid Oak legs with a clear finish
  - Plastic glides with felt

Frame Finishes:

Off Black	
White	
Crayon Grey	
Pistachio	
Seattle Green	
Aubergine	

Solid Wood Finishes:

Clear on Beech	
Clear on Oak	

For larger swatches go to pg.172-176

6 optional Wood Stains and 8 colour washes based on Beech are also available please go to pg.177 and 178 to see more.

**Folk - FLK100U3**  
Chair with upholstered seat and back

Dimensions:

Seat Height	440mm
Seat Width	455mm
Seat Depth	435mm
Overall Height	790mm
Overall Width	475mm
Overall Depth	505mm

- Standard Features:
- Upholstered seat and back
  - Cast Aluminium frame in Off Black powder coat with Beech ply legs in a clear finish
  - Plastic glides
  - Stacks up to 4 high

- Optional Features:
- Cast Aluminium frame available in a selection of powder coat finishes
  - Solid Beech legs can be stained or colour washed
  - Solid Oak legs with a clear finish
  - Plastic glides with felt
  - Multi-Fabrics

Frame Finishes:

Off Black	
White	
Crayon Grey	
Pistachio	
Seattle Green	
Aubergine	

Solid Wood Finishes:

Clear on Beech	
Clear on Oak	

For larger swatches go to pg.172-176

6 optional Wood Stains and 8 colour washes based on Beech are also available please go to pg.177 and 178 to see more.

**Folk - FLK103**  
Chair with plastic seat and back

Dimensions:

Seat Height	440mm
Seat Width	455mm
Seat Depth	435mm
Overall Height	790mm
Overall Width	475mm
Overall Depth	505mm

- Standard Features:
- Off Black plastic seat, back and Aluminium frame with Clear Beech legs as standard
  - Plastic glides
  - Stacks up to 4 high

- Optional Features:
- Cast Aluminium frame and plastic seat and back available in a selection of powder coat finishes
  - Solid Beech legs can be stained or colour washed
  - Solid Oak legs with a clear finish
  - Plastic glides with felt

Frame Finishes:

Off Black	
White	
Crayon Grey	
Pistachio	
Seattle Green	
Aubergine	

Solid Wood Finishes:

Clear on Beech	
Clear on Oak	

For larger swatches go to pg.172-176

6 optional Wood Stains and 8 colour washes based on Beech are also available please go to pg.177 and 178 to see more.

**Folk - FLK103U1**  
Chair with plastic back and upholstered seat

Dimensions:

Seat Height	440mm
Seat Width	455mm
Seat Depth	435mm
Overall Height	790mm
Overall Width	475mm
Overall Depth	505mm

- Standard Features:
- Off Black plastic back and Aluminium frame with Clear Beech legs as standard
  - Upholstered Seat
  - Plastic glides
  - Stacks up to 4 high

- Optional Features:
- Cast Aluminium frame and plastic back available in a selection of powder coat finishes
  - Solid Beech legs can be stained or colour washed
  - Solid Oak legs with a clear finish
  - Plastic glides with felt

Frame Finishes:

Off Black	
White	
Crayon Grey	
Pistachio	
Seattle Green	
Aubergine	

Solid Wood Finishes:

Clear on Beech	
Clear on Oak	

For larger swatches go to pg.172-176

6 optional Wood Stains and 8 colour washes based on Beech are also available please go to pg.177 and 178 to see more.



↓ Scan here to discover more



↓ Scan here to discover more



# Folk

Design by Pearson Lloyd

28

29

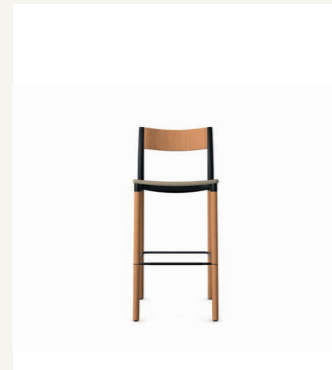
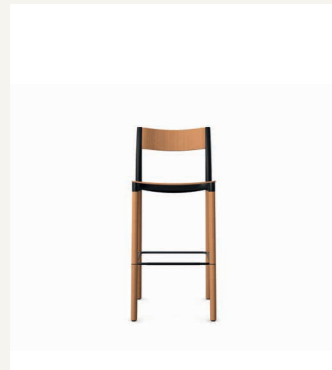

**Folk - FLK301**  
Stool with wood seat and back

Dimensions:  
 Seat Height 755mm  
 Seat Width 455mm  
 Seat Depth 435mm  
 Overall Height 1100mm  
 Overall Width 475mm  
 Overall Depth 520mm

- Standard Features:
- Off Black Aluminium frame with Clear Beech back, seat and legs as standard
  - Footrest finished in Off Black powder coat
  - Footrest protector
  - Plastic glides

- Optional Features:
- Cast Aluminium frame available in a selection of powder coat finishes
  - Beech ply seat, back and solid Beech legs can be stained or colour washed
  - Oak ply seat, back and solid Oak legs with a clear finish
  - Plastic glides with felt

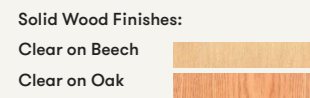
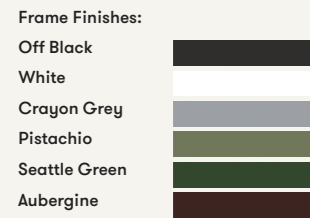

For larger swatches go to pg.172-176

6 optional Wood Stains and 8 colour washes based on Beech are also available please go to pg.177 and 178 to see more.



**Folk - FLK301U1**  
Stool with wood back and upholstered seat

Dimensions:  
 Seat Height 755mm  
 Seat Width 455mm  
 Seat Depth 435mm  
 Overall Height 1100mm  
 Overall Width 475mm  
 Overall Depth 520mm

- Standard Features:
- Off Black Aluminium frame with Clear Beech back and legs as standard
  - Footrest finished in Off Black powder coat
  - Upholstered Seat
  - Footrest protector
  - Plastic glides

- Optional Features:
- Cast Aluminium frame available in a selection of powder coat finishes
  - Beech ply seat, back and solid Beech legs can be stained or colour washed
  - Oak ply back and solid Oak legs with a clear finish
  - Plastic glides with felt

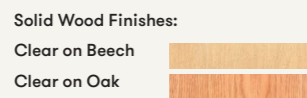
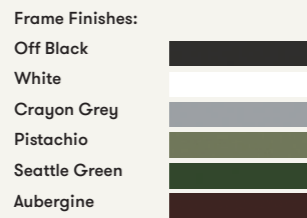

For larger swatches go to pg.172-176

6 optional Wood Stains and 8 colour washes based on Beech are also available please go to pg.177 and 178 to see more.



# Folk

Design by Pearson Lloyd

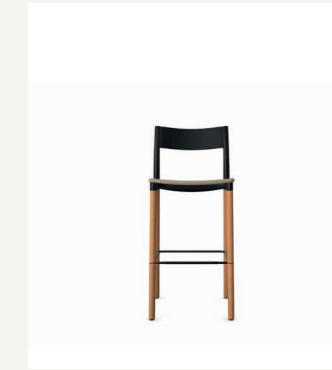
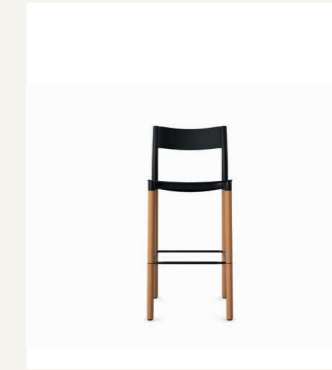
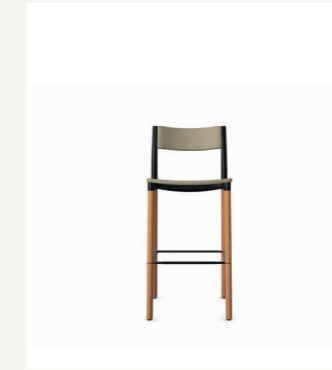

**Folk - FLK300U3**  
Stool with upholstered seat and back

Dimensions:  
 Seat Height 755mm  
 Seat Width 455mm  
 Seat Depth 435mm  
 Overall Height 1100mm  
 Overall Width 475mm  
 Overall Depth 520mm

- Standard Features and Finishes:
- Off Black Aluminium frame with Clear Beech legs as standard
  - Upholstered seat and back
  - Footrest finished in Off Black powder coat
  - Footrest protector
  - Plastic glides

- Optional Features:
- Cast Aluminium frame available in a selection of powder coat finishes
  - Solid Beech legs can be stained or colour washed
  - Solid Oak legs with a clear finish
  - Plastic glides with felt
  - Multi-Fabrics

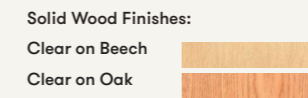

For larger swatches go to pg.172-176

6 optional Wood Stains and 8 colour washes based on Beech are also available please go to pg.177 and 178 to see more.



**Folk - FLK303**  
Stool with plastic seat and back

Dimensions:  
 Seat Height 755mm  
 Seat Width 455mm  
 Seat Depth 435mm  
 Overall Height 1100mm  
 Overall Width 475mm  
 Overall Depth 520mm

- Standard Features and Finishes:
- Off Black plastic seat, back and Aluminium frame with Clear Beech legs as standard
  - Footrest finished in Off Black powder coat
  - Footrest protector
  - Plastic glides

- Optional Features:
- Plastic seat, back and Aluminium frame available in a selection of powder coat finishes
  - Solid Beech legs can be stained or colour washed
  - Solid Oak legs with a clear finish
  - Plastic glides with felt

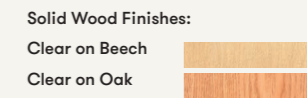
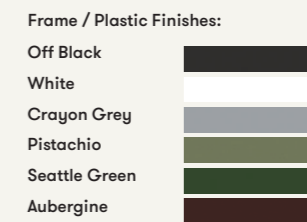

For larger swatches go to pg.172-176

6 optional Wood Stains and 8 colour washes based on Beech are also available please go to pg.177 and 178 to see more.



**Folk - FLK303U1**  
Stool with plastic back and upholstered seat

Dimensions:  
 Seat Height 755mm  
 Seat Width 455mm  
 Seat Depth 435mm  
 Overall Height 1100mm  
 Overall Width 475mm  
 Overall Depth 520mm

- Standard Features and Finishes:
- Off Black plastic back and Aluminium frame with Clear Beech legs as standard
  - Footrest finished in Off Black powder coat
  - Upholstered Seat
  - Footrest protector
  - Plastic glides

- Optional Features:
- Plastic back and Aluminium frame available in a selection of powder coat finishes
  - Solid Beech legs can be stained or colour washed
  - Solid Oak legs with a clear finish
  - Plastic glides with felt

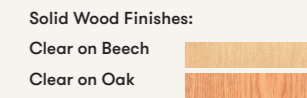
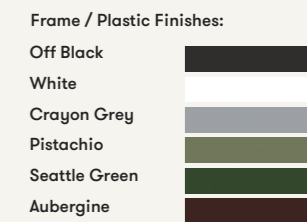

For larger swatches go to pg.172-176

6 optional Wood Stains and 8 colour washes based on Beech are also available please go to pg.177 and 178 to see more.



↓ Scan here to discover more



↓ Scan here to discover more



↓ Scan here to discover more



↓ Scan here to discover more



↓ Scan here to discover more



# Jojo

Design By Foersom & Hiort-Lorenzen

30

31

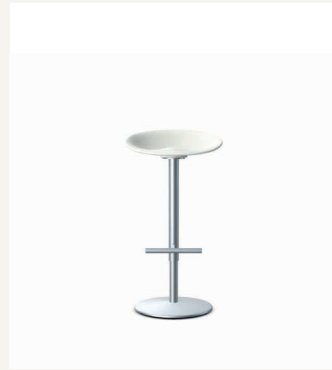

Jojo - A595  
High stool height adjustable

Dimensions:  
Seat Height 665mm  
Seat Width 380mm  
Seat Depth 380mm  
Overall Height 900mm  
Overall Width 480mm  
Overall Depth 430mm

- Standard Features:
- Rigid PU shell finished in Pure White
  - Height adjustable Steel swivel pedestal base finished in Polished Chrome
  - Plastic glides

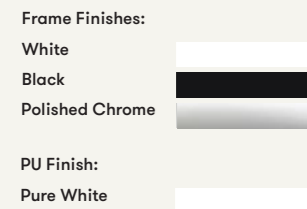

For larger swatches go to pg.172-174

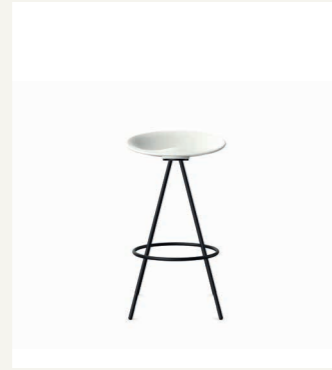

Jojo - A596  
High stool

Dimensions:  
Seat Height 755mm  
Seat Width 380mm  
Seat Depth 380mm  
Overall Height 875mm  
Overall Width 480mm  
Overall Depth 430mm

- Standard Features:
- Rigid PU shell finished in Pure White
  - Tubular Steel frame finished in Silver M04
  - Plastic glides

- Optional Features:
- Tubular Steel frame available in a selection of colours
  - Polished Chrome frame
  - Counter height stool option, seat height 625mm (add CH to product code)

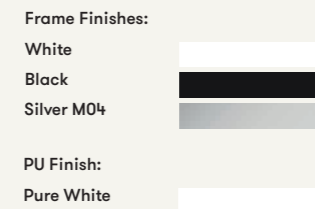

For larger swatches go to pg.172-174

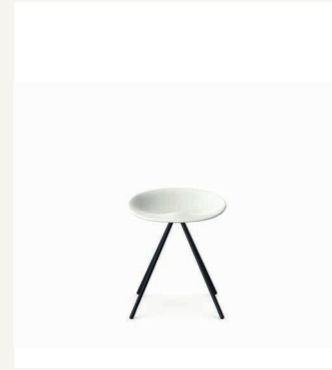

Jojo - A597  
Low stool

Dimensions:  
Seat Height 465mm  
Seat Width 480mm  
Seat Depth 380mm  
Overall Height 580mm  
Overall Width 480mm  
Overall Depth 430mm

- Standard Features:
- Rigid PU shell finished in Pure White
  - Tubular Steel frame finished in Silver M04
  - Plastic glides

- Optional Features:
- Tubular Steel frame available in a selection of colours
  - Polished Chrome frame

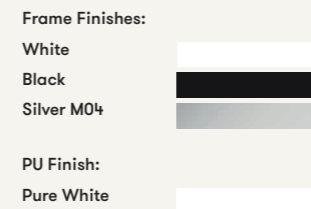

For larger swatches go to pg.172-174



↓ Scan here to discover more



↓ Scan here to discover more



# Kin

Design by Pearson Lloyd

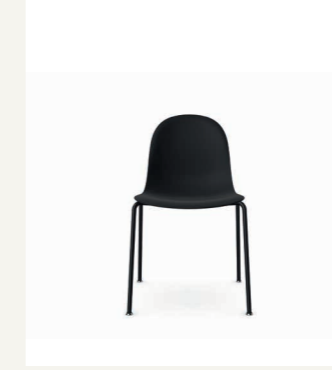

Kin - KIN102  
Side chair on 4 leg frame

Dimensions:  
Seat Height 450mm  
Seat Width 460mm  
Seat Depth 475mm  
Overall Height 820mm  
Overall Width 520mm  
Overall Depth 535mm

- Standard Features:
- Plastic shell finished in Off Black
  - Tubular steel frame finished in Off Black powder coat
  - Plastic glides
  - Stacks up to 4 high

- Optional Features:
- Plastic shell available in a selection of colours with complementary powder coat base or frame
  - Plastic glides with felt



For larger swatches go to pg.172-174

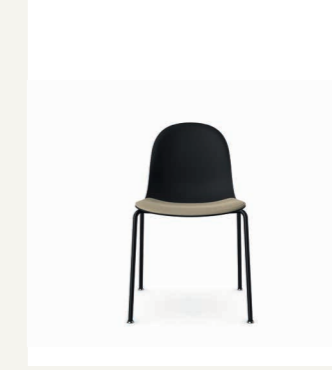

Kin - KIN102U1  
Side chair with upholstered seat on 4 leg frame

Dimensions:  
Seat Height 450mm  
Seat Width 460mm  
Seat Depth 475mm  
Overall Height 820mm  
Overall Width 520mm  
Overall Depth 535mm

- Standard Features:
- Plastic shell finished in Off Black
  - Upholstered seat pad
  - Tubular steel frame finished in Off Black powder coat
  - Plastic glides
  - Stacks up to 4 high

- Optional Features:
- Plastic shell available in a selection of colours with complementary powder coat base or frame
  - Plastic glides with felt



For larger swatches go to pg.172-174

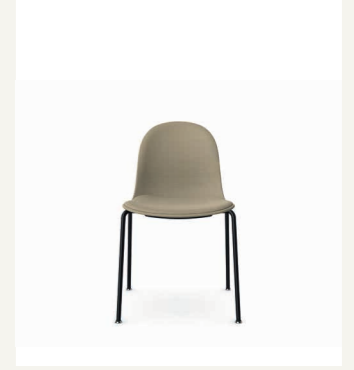

Kin - KIN102U3  
Side chair fully upholstered on 4 leg frame

Dimensions:  
Seat Height 450mm  
Seat Width 460mm  
Seat Depth 475mm  
Overall Height 820mm  
Overall Width 520mm  
Overall Depth 535mm

- Standard Features:
- Fully upholstered shell
  - Tubular Steel frame finished in Off Black powder coat
  - Plastic glides
  - Stacks up to 4 high

- Optional Features:
- Plastic glides with felt
  - Multi-Fabrics



For larger swatches go to pg.172-174





# Kin

Design by Pearson Lloyd

32

33

# Kin

Design by Pearson Lloyd

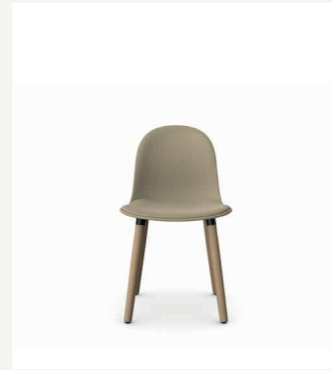

**Kin - KIN103**  
Side chair on wood legs

Dimensions:  
 Seat Height 450mm  
 Seat Width 460mm  
 Seat Depth 475mm  
 Overall Height 815mm  
 Overall Width 460mm  
 Overall Depth 535mm

- Standard Features:**
- Plastic shell finished in Off Black
  - Aluminium leg connector frame finished in Off Black powder coat
  - Solid Ash legs with a clear finish
  - Plastic glides

- Optional Features:**
- Plastic shell available in a selection of colours with complementary powder coat base or frame
  - Solid Ash legs can be stained or colour matched to complement shell
  - Plastic glides with felt

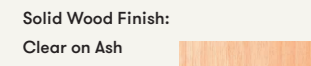

For larger swatches go to pg.172-176

6 optional Wood Stains and 8 colour washes based on Ash are also available please go to pg.177 and 178 to see more.

**Kin - KIN103U1**  
Side chair with upholstered seat on 4 wood legs

Dimensions:  
 Seat Height 450mm  
 Seat Width 460mm  
 Seat Depth 475mm  
 Overall Height 815mm  
 Overall Width 460mm  
 Overall Depth 535mm

- Standard Features:**
- Plastic shell finished in Off Black
  - Upholstered seat pad
  - Aluminium leg connector frame finished in Off Black powder coat
  - Solid Ash legs with a clear finish
  - Plastic glides

- Optional Features:**
- Plastic shell available in a selection of colours with complementary powder coat base or frame
  - Solid Ash legs can be stained or colour matched to complement shell
  - Plastic glides with felt

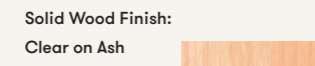

For larger swatches go to pg.172-176

6 optional Wood Stains and 8 colour washes based on Ash are also available please go to pg.177 and 178 to see more.

**Kin - KIN103U3**  
Side chair fully upholstered on wood legs

Dimensions:  
 Seat Height 450mm  
 Seat Width 460mm  
 Seat Depth 475mm  
 Overall Height 815mm  
 Overall Width 460mm  
 Overall Depth 535mm

- Standard Features:**
- Fully upholstered shell
  - Aluminium leg connector frame finished in Off Black powder coat
  - Solid Ash legs with a clear finish
  - Plastic glides

- Optional Features:**
- Solid Ash legs can be stained or colour matched to complement shell
  - Plastic glides with felt
  - Multi-Fabrics

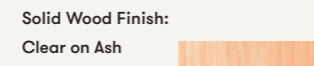

For larger swatches go to pg.172-176

6 optional Wood Stains and 8 colour washes based on Ash are also available please go to pg.177 and 178 to see more.



↓ Scan here to discover more



↓ Scan here to discover more

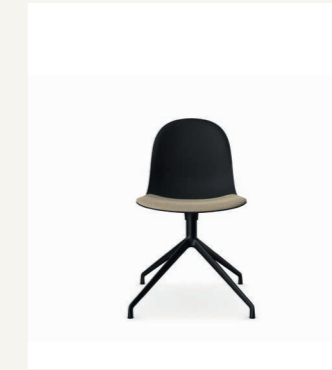
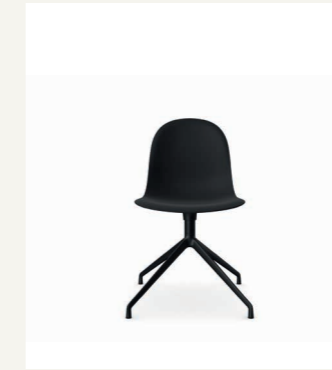

**Kin - KIN104**  
Side chair on 4 star swivel base

Dimensions:  
 Seat Height 450mm  
 Seat Width 460mm  
 Seat Depth 475mm  
 Overall Height 815mm  
 Overall Width 515mm  
 Overall Depth 535mm

- Standard Features:**
- Plastic shell finished in Off Black
  - 4 star swivel base on glides finished in Off Black powder coat
  - Plastic glides

- Optional Features:**
- Plastic shell available in a selection of colours with complementary powder coat base or frame
  - 4 star auto return base on glides
  - 4 star fixed base on 50mm hard wheel casters
  - Plastic glides with felt



For larger swatches go to pg.172-174

**Kin - KIN104U1**  
Side chair with upholstered seat on 4 star swivel base

Dimensions:  
 Seat Height 450mm  
 Seat Width 460mm  
 Seat Depth 475mm  
 Overall Height 815mm  
 Overall Width 515mm  
 Overall Depth 535mm

- Standard Features:**
- Plastic shell finished in Off Black
  - Upholstered seat pad
  - 4 star swivel base on glides finished in Off Black powder coat
  - Plastic glides

- Optional Features:**
- Plastic shell available in a selection of colours with complementary powder coat base or frame
  - 4 star auto return base on glides
  - 4 star fixed base on 50mm hard wheel casters
  - Plastic glides with felt

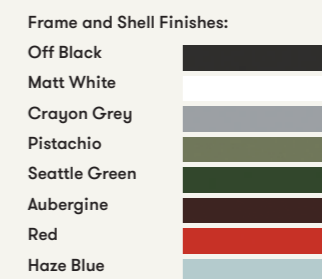

For larger swatches go to pg.172-174

**Kin - KIN104U3**  
Side chair fully upholstered on 4 star swivel base

Dimensions:  
 Seat Height 450mm  
 Seat Width 460mm  
 Seat Depth 475mm  
 Overall Height 815mm  
 Overall Width 515mm  
 Overall Depth 535mm

- Standard Features:**
- Fully upholstered shell
  - 4 star swivel base on glides finished in Off Black powder coat
  - Plastic glides

- Optional Features:**
- 4 star auto return base on glides
  - 4 star fixed base on 50mm hard wheel casters
  - Plastic glides with felt
  - Multi-Fabrics



For larger swatches go to pg.172-174



# Kin

Design by Pearson Lloyd

34

35

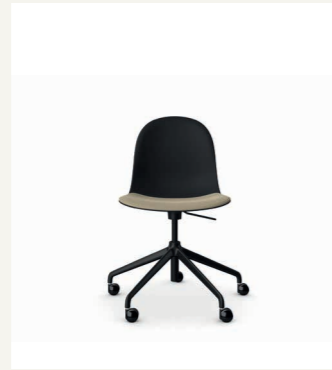

**Kin - KIN105**  
Side chair on 5 star swivel base

Dimensions:  
 Seat Height 450mm  
 Seat Width 460mm  
 Seat Depth 475mm  
 Overall Height 825mm  
 Overall Width 625mm  
 Overall Depth 600mm

Standard Features:  
 — Plastic shell finished in Off Black  
 — 5 star swivel base with height adjustment on casters finished in Off Black powder coat  
 — 50mm hard wheel casters

Optional Features:  
 — Plastic shell available in a selection of colours with complementary powder coat base or frame  
 — Soft wheel casters



For larger swatches go to pg.172-174

**Kin - KIN105U1**  
Side chair with upholstered seat on 5 star swivel base

Dimensions:  
 Seat Height 450mm  
 Seat Width 460mm  
 Seat Depth 475mm  
 Overall Height 825mm  
 Overall Width 625mm  
 Overall Depth 600mm

Standard Features:  
 — Plastic shell finished in Off Black  
 — Upholstered seat pad  
 — 5 star swivel base with height adjustment on casters finished in Off Black powder coat  
 — 50mm hard wheel casters

Optional Features:  
 — Plastic shell available in a selection of colours with complementary powder coat base or frame  
 — Soft wheel casters



For larger swatches go to pg.172-174

**Kin - KIN105U3**  
Side chair fully upholstered on 5 star swivel base

Dimensions:  
 Seat Height 450mm  
 Seat Width 460mm  
 Seat Depth 475mm  
 Overall Height 825mm  
 Overall Width 625mm  
 Overall Depth 600mm

Standard Features:  
 — Fully upholstered shell  
 — 5 star swivel base with height adjustment on casters finished in Off Black powder coat  
 — 50mm hard wheel casters

Optional Features:  
 — Soft wheel casters  
 — Multi-Fabrics



For larger swatches go to pg.172-174



↓ Scan here to discover more



↓ Scan here to discover more



# Kin

Design by Pearson Lloyd

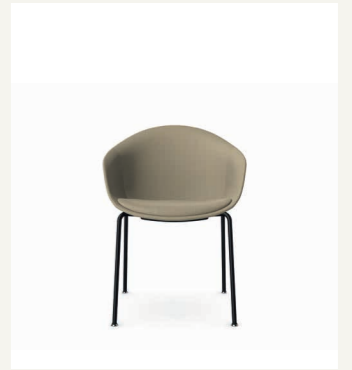
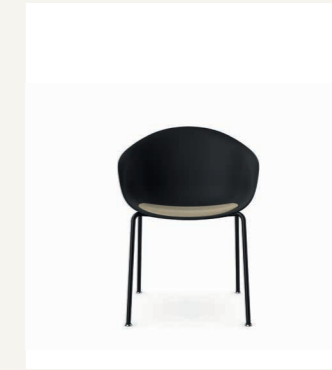
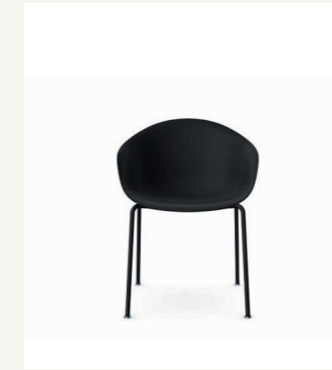

**Kin - KIN302**  
Tub chair on 4 leg frame

Dimensions:  
 Seat Height 450mm  
 Seat Width 490mm  
 Seat Depth 475mm  
 Overall Height 820mm  
 Overall Width 600mm  
 Overall Depth 560mm

Standard Features:  
 — Plastic shell finished in Off Black  
 — Tubular steel frame finished in Off Black powder coat  
 — Plastic glides

Optional Features:  
 — Plastic shell available in a selection of colours with complementary powder coat base or frame  
 — Plastic glides with felt



For larger swatches go to pg.172-174



**Kin - KIN302U1**  
Tub chair with upholstered seat on 4 leg frame

Dimensions:  
 Seat Height 450mm  
 Seat Width 490mm  
 Seat Depth 475mm  
 Overall Height 820mm  
 Overall Width 600mm  
 Overall Depth 560mm

Standard Features:  
 — Plastic shell finished in Off Black  
 — Upholstered seat pad  
 — Tubular steel frame finished in Off Black powder coat  
 — Plastic glides

Optional Features:  
 — Plastic shell available in a selection of colours with complementary powder coat base or frame  
 — Plastic glides with felt



For larger swatches go to pg.172-174

**Kin - KIN302U3**  
Tub chair fully upholstered on 4 leg frame

Dimensions:  
 Seat Height 450mm  
 Seat Width 490mm  
 Seat Depth 475mm  
 Overall Height 820mm  
 Overall Width 600mm  
 Overall Depth 560mm

Standard Features:  
 — Fully upholstered shell  
 — Tubular steel frame finished in Off Black powder coat  
 — Plastic glides

Optional Features:  
 — Plastic glides with felt  
 — Multi-Fabrics



For larger swatches go to pg.172-174

# Kin

Design by Pearson Lloyd

36

37

# Kin

Design by Pearson Lloyd

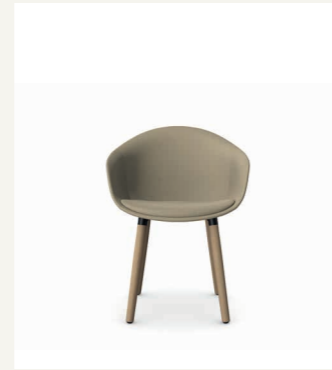
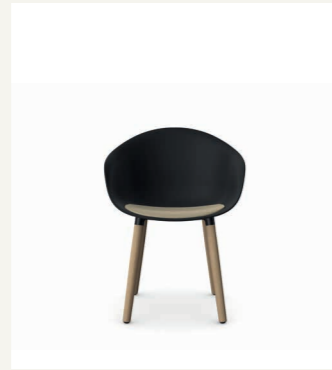

**Kin - KIN303**  
Tub chair on wood legs

Dimensions:  
 Seat Height 450mm  
 Seat Width 490mm  
 Seat Depth 475mm  
 Overall Height 810mm  
 Overall Width 600mm  
 Overall Depth 560mm

- Standard Features:**
- Plastic shell finished in Off Black
  - Aluminium leg connector frame finished in Off Black powder coat
  - Solid Ash legs with a clear finish
  - Plastic glides

- Optional Features:**
- Plastic shell available in a selection of colours with complementary powder coat base or frame
  - Solid Ash legs can be stained or colour matched to complement shell
  - Plastic glides with felt

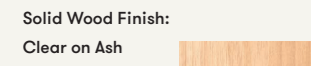

For larger swatches go to pg.172-176

6 optional Wood Stains and 8 colour washes based on Ash are also available please go to pg.177 and 178 to see more.

**Kin - KIN303U1**  
Tub chair with upholstered seat on wood legs

Dimensions:  
 Seat Height 450mm  
 Seat Width 490mm  
 Seat Depth 475mm  
 Overall Height 810mm  
 Overall Width 600mm  
 Overall Depth 560mm

- Standard Features:**
- Plastic shell finished in Off Black
  - Upholstered seat pad
  - Aluminium leg connector frame finished in Off Black powder coat
  - Solid Ash legs with a clear finish
  - Plastic glides

- Optional Features:**
- Plastic shell available in a selection of colours with complementary powder coat base or frame
  - Solid Ash legs can be stained or colour matched to complement shell
  - Plastic glides with felt

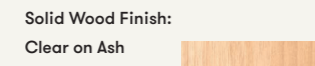

For larger swatches go to pg.172-176

6 optional Wood Stains and 8 colour washes based on Ash are also available please go to pg.177 and 178 to see more.

**Kin - KIN303U3**  
Tub chair fully upholstered on wood legs

Dimensions:  
 Seat Height 450mm  
 Seat Width 490mm  
 Seat Depth 475mm  
 Overall Height 810mm  
 Overall Width 600mm  
 Overall Depth 560mm

- Standard Features:**
- Fully upholstered shell
  - Aluminium leg connector frame finished in Off Black powder coat
  - Solid Ash legs with a clear finish
  - Plastic glides

- Optional Features:**
- Solid Ash legs can be stained or colour matched to complement shell
  - Plastic glides with felt
  - Multi-Fabrics

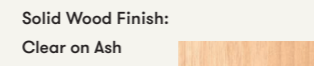

For larger swatches go to pg.172-176

6 optional Wood Stains and 8 colour washes based on Ash are also available please go to pg.177 and 178 to see more.



↓ Scan here to discover more



↓ Scan here to discover more

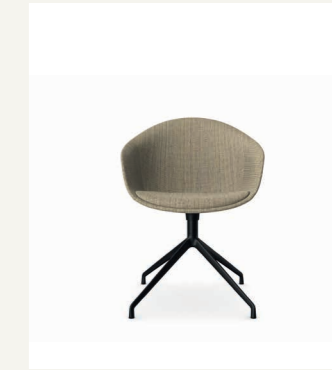
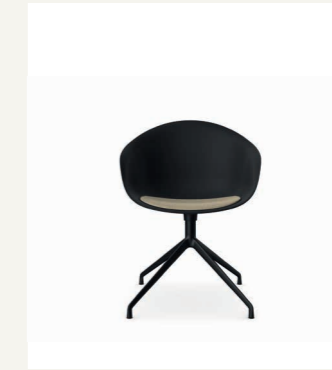
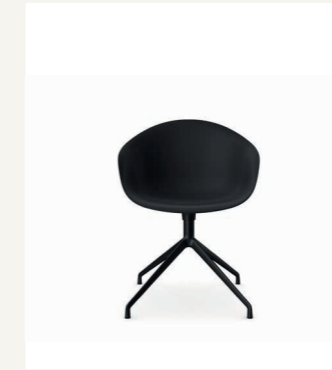

**Kin - KIN304**  
Tub chair on 4 star swivel base

Dimensions:  
 Seat Height 450mm  
 Seat Width 490mm  
 Seat Depth 475mm  
 Overall Height 815mm  
 Overall Width 600mm  
 Overall Depth 560mm

- Standard Features:**
- Plastic shell finished in Off Black
  - 4 star swivel base on glides finished in Off Black powder coat
  - Plastic glides

- Optional Features:**
- Plastic shell available in a selection of colours with complementary powder coat base or frame
  - 4 star auto return base on glides
  - 4 star fixed base on 50mm hard wheel casters
  - Plastic glides with felt



For larger swatches go to pg.172-174

**Kin - KIN304U1**  
Tub chair with upholstered seat on 4 star swivel base

Dimensions:  
 Seat Height 450mm  
 Seat Width 490mm  
 Seat Depth 475mm  
 Overall Height 815mm  
 Overall Width 600mm  
 Overall Depth 560mm

- Standard Features:**
- Plastic shell finished in Off Black
  - Upholstered seat pad
  - 4 star swivel base on glides finished in Off Black powder coat
  - Plastic glides

- Optional Features:**
- Plastic shell available in a selection of colours with complementary powder coat base or frame
  - 4 star auto return base on glides
  - 4 star fixed base on 50mm hard wheel casters
  - Plastic glides with felt



For larger swatches go to pg.172-174

**Kin - KIN304U3**  
Tub chair fully upholstered on 4 star swivel base

Dimensions:  
 Seat Height 450mm  
 Seat Width 490mm  
 Seat Depth 475mm  
 Overall Height 815mm  
 Overall Width 600mm  
 Overall Depth 560mm

- Standard Features:**
- Fully upholstered shell
  - 4 star swivel base on glides finished in Off Black powder coat
  - Plastic glides

- Optional Features:**
- 4 star auto return base on glides
  - 4 star fixed base on 50mm hard wheel casters
  - Plastic glides with felt
  - Multi-Fabrics



For larger swatches go to pg.172-174



# Kin

Design by Pearson Lloyd

38

39

# Kin

Design by Pearson Lloyd



**Kin - KIN305**  
Tub chair on 5 star swivel base

Dimensions:  
 Seat Height 450mm  
 Seat Width 490mm  
 Seat Depth 475mm  
 Overall Height 820mm  
 Overall Width 625mm  
 Overall Depth 610mm

- Standard Features:**
- Plastic shell finished in Off Black
  - 5 star swivel base with height adjustment on casters finished in Off Black powder coat
  - 50mm hard wheel casters

- Optional Features:**
- Plastic shell available in a selection of colours with complementary powder coat base or frame
  - Plastic glides with felt



For larger swatches go to pg.172-174

**Kin - KIN305U1**  
Tub chair with upholstered seat on 5 star swivel base

Dimensions:  
 Seat Height 450mm  
 Seat Width 490mm  
 Seat Depth 475mm  
 Overall Height 820mm  
 Overall Width 625mm  
 Overall Depth 610mm

- Standard Features:**
- Plastic shell finished in Off Black
  - Upholstered seat pad
  - 5 star swivel base with height adjustment on casters finished in Off Black powder coat
  - 50mm hard wheel casters

- Optional Features:**
- Plastic shell available in a selection of colours with complementary powder coat base or frame
  - Soft wheel casters



For larger swatches go to pg.172-174

**Kin - KIN305U3**  
Tub chair fully upholstered on 5 star swivel base

Dimensions:  
 Seat Height 450mm  
 Seat Width 490mm  
 Seat Depth 475mm  
 Overall Height 820mm  
 Overall Width 625mm  
 Overall Depth 610mm

- Standard Features:**
- Fully upholstered shell
  - 5 star swivel base with height adjustment on casters finished in Off Black powder coat
  - 50mm hard wheel casters

- Optional Features:**
- Soft wheel casters
  - Multi-Fabrics



For larger swatches go to pg.172-174



↓ Scan here to discover more



↓ Scan here to discover more

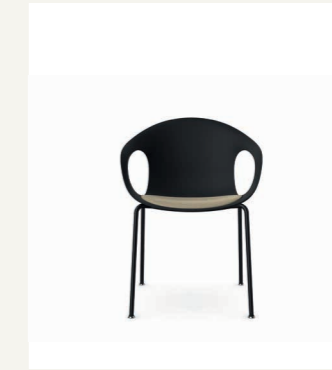
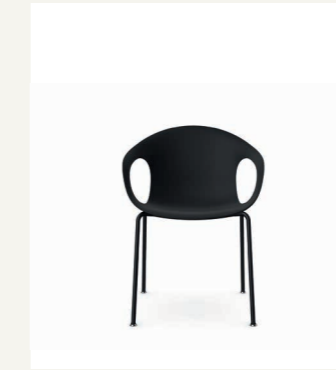

**Kin - KIN202**  
Arm chair on 4 leg frame

Dimensions:  
 Seat Height 450mm  
 Seat Width 490mm  
 Seat Depth 475mm  
 Overall Height 820mm  
 Overall Width 600mm  
 Overall Depth 560mm

- Standard Features:**
- Plastic shell finished in Off Black
  - Tubular steel frame finished in Off Black powder coat
  - Plastic glides
  - Stacks up to 4 high

- Optional Features:**
- Plastic shell available in a selection of colours with complementary powder coat base or frame
  - Plastic glides with felt



For larger swatches go to pg.172-174

**Kin - KIN202U1**  
Arm chair with upholstered seat on 4 leg frame

Dimensions:  
 Seat Height 450mm  
 Seat Width 490mm  
 Seat Depth 475mm  
 Overall Height 820mm  
 Overall Width 600mm  
 Overall Depth 560mm

- Standard Features:**
- Plastic shell finished in Off Black
  - Upholstered seat pad
  - Tubular steel frame finished in Off Black powder coat
  - Plastic glides
  - Stacks up to 4 high

- Optional Features:**
- Plastic shell available in a selection of colours with complementary powder coat base or frame
  - Plastic glides with felt

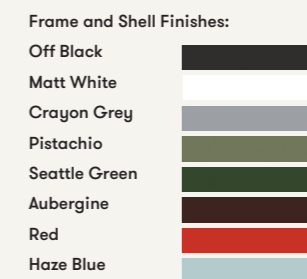

For larger swatches go to pg.172-174



# Kin

Design by Pearson Lloyd

40

41

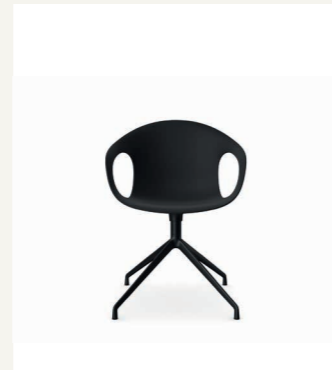
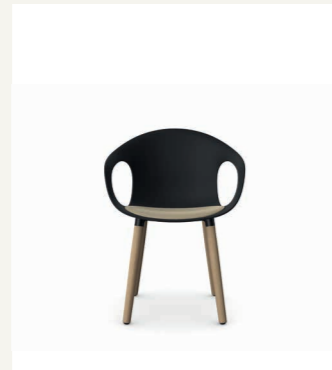
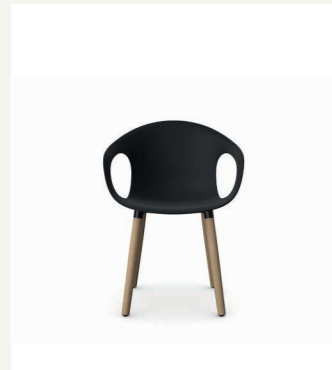

**Kin - KIN203**  
Arm chair on wood legs

**Dimensions:**  
 Seat Height 450mm  
 Seat Width 490mm  
 Seat Depth 475mm  
 Overall Height 810mm  
 Overall Width 600mm  
 Overall Depth 560mm

**Standard Features:**  
 — Plastic shell finished in Off Black  
 — Aluminium leg connector frame finished in Off Black powder coat  
 — Solid Ash legs with a clear finish  
 — Plastic glides

**Optional Features:**  
 — Plastic shell available in a selection of colours with complementary powder coat base or frame  
 — Solid Ash legs can be stained or colour matched to complement shell  
 — Plastic glides with felt



For larger swatches go to pg.172-176

6 optional Wood Stains and 8 colour washes based on Ash are also available please go to pg.177 and 178 to see more.



**Kin - KIN203U1**  
Arm chair with upholstered seat with wood legs

**Dimensions:**  
 Seat Height 450mm  
 Seat Width 490mm  
 Seat Depth 475mm  
 Overall Height 810mm  
 Overall Width 600mm  
 Overall Depth 560mm

**Standard Features:**  
 — Plastic shell finished in Off Black  
 — Upholstered seat pad  
 — Aluminium leg connector frame finished in Off Black powder coat  
 — Solid Ash legs with a clear finish  
 — Plastic glides

**Optional Features:**  
 — Plastic shell available in a selection of colours with complementary powder coat base or frame  
 — Solid Ash legs can be stained or colour matched to complement shell  
 — Plastic glides with felt

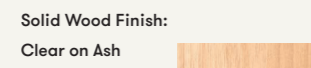

For larger swatches go to pg.172-176

6 optional Wood Stains and 8 colour washes based on Ash are also available please go to pg.177 and 178 to see more.



**Kin - KIN204**  
Arm chair on 4 star swivel base

**Dimensions:**  
 Seat Height 450mm  
 Seat Width 490mm  
 Seat Depth 475mm  
 Overall Height 810mm  
 Overall Width 600mm  
 Overall Depth 560mm

**Standard Features:**  
 — Plastic shell finished in Off Black  
 — 4 star swivel base on glides  
 — Plastic glides

**Optional Features:**  
 — Plastic shell available in a selection of colours with complementary powder coat base or frame  
 — 4 star auto return base on glides  
 — 4 star fixed base on 50mm hard wheel casters  
 — Plastic glides with felt

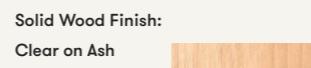

For larger swatches go to pg.172-176

6 optional Wood Stains and 8 colour washes based on Ash are also available please go to pg.177 and 178 to see more.



↓ Scan here to discover more



# Kin

Design by Pearson Lloyd

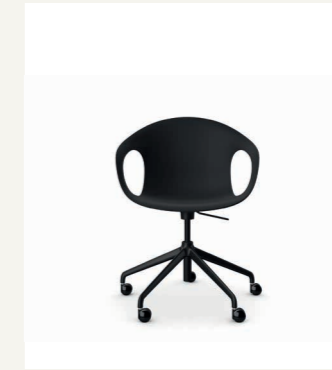
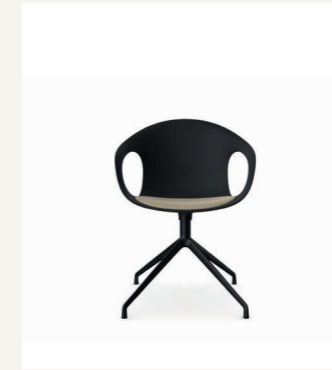

**Kin - KIN204U1**  
Arm chair with upholstered seat on 4 star swivel base

**Dimensions:**  
 Seat Height 450mm  
 Seat Width 490mm  
 Seat Depth 475mm  
 Overall Height 810mm  
 Overall Width 600mm  
 Overall Depth 560mm

**Standard Features:**  
 — Plastic shell finished in Off Black  
 — Upholstered seat pad  
 — 4 star swivel base on glides finished in Off Black powder coat  
 — Plastic glides

**Optional Features:**  
 — Plastic shell available in a selection of colours with complementary powder coat base or frame  
 — 4 star auto return base on glides  
 — 4 star fixed base on 50mm hard wheel casters  
 — Plastic glides with felt



For larger swatches go to pg.172-174



**Kin - KIN205**  
Arm chair on 5 star swivel base

**Dimensions:**  
 Seat Height 450mm  
 Seat Width 490mm  
 Seat Depth 475mm  
 Overall Height 820mm  
 Overall Width 625mm  
 Overall Depth 610mm

**Standard Features:**  
 — Plastic shell finished in Off Black  
 — 5 star swivel base with height adjustment on casters finished in Off Black powder coat  
 — 50mm hard wheel casters

**Optional Features:**  
 — Plastic shell available in a selection of colours with complementary powder coat base or frame  
 — Soft wheel casters



For larger swatches go to pg.172-174



**Kin - KIN205U1**  
Arm chair with upholstered seat on 5 star swivel base

**Dimensions:**  
 Seat Height 450mm  
 Seat Width 490mm  
 Seat Depth 475mm  
 Overall Height 820mm  
 Overall Width 625mm  
 Overall Depth 610mm

**Standard Features:**  
 — Plastic shell finished in Off Black  
 — Upholstered seat pad  
 — 5 star swivel base with height adjustment on casters finished in Off Black powder coat  
 — 50mm hard wheel casters

**Optional Features:**  
 — Plastic shell available in a selection of colours with complementary powder coat base or frame  
 — Soft wheel casters



For larger swatches go to pg.172-174



↓ Scan here to discover more



# Kin

Design by Pearson Lloyd

42

43

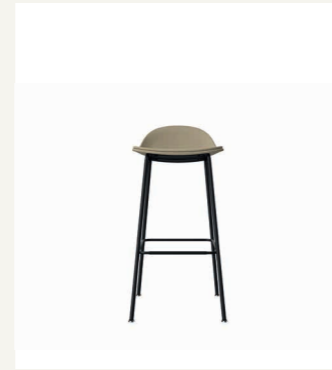
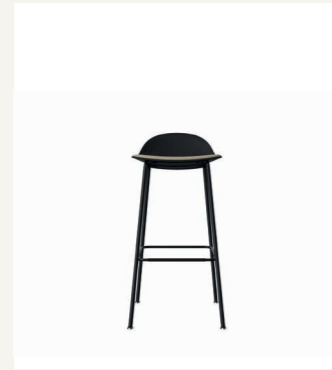
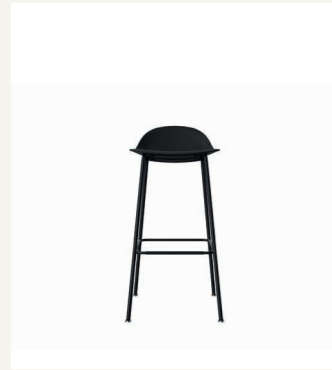

**Kin - KIN502**  
Low back stool on 4 leg frame

Dimensions:  
 Seat Height 745mm  
 Seat Width 410mm  
 Seat Depth 375mm  
 Overall Height 885mm  
 Overall Width 445mm  
 Overall Depth 460mm

Standard Features:  
 — Plastic shell finished in Off Black  
 — Tubular steel frame finished in Off Black powder coat  
 — Footrest protector  
 — Plastic glides

Optional Features:  
 — Plastic shell available in a selection of colours with complementary powder coat base or frame  
 — Plastic glides with felt  
 — Counter height stool option, seat height 625mm (add CH to product code)



For larger swatches go to pg.172-174

**Kin - KIN502U1**  
Low back stool with upholstered seat on 4 leg frame

Dimensions:  
 Seat Height 745mm  
 Seat Width 410mm  
 Seat Depth 375mm  
 Overall Height 885mm  
 Overall Width 445mm  
 Overall Depth 460mm

Standard Features:  
 — Plastic shell finished in Off Black  
 — Upholstered seat pad  
 — Tubular steel frame finished in Off Black powder coat  
 — Footrest protector  
 — Plastic glides

Optional Features:  
 — Plastic shell available in a selection of colours with complementary powder coat base or frame  
 — Plastic glides with felt  
 — Counter height stool option, seat height 625mm (add CH to product code)



For larger swatches go to pg.172-174

**Kin - KIN502U3**  
Fully upholstered low back stool on 4 leg frame

Dimensions:  
 Seat Height 745mm  
 Seat Width 410mm  
 Seat Depth 375mm  
 Overall Height 885mm  
 Overall Width 445mm  
 Overall Depth 460mm

Standard Features:  
 — Fully upholstered shell  
 — Tubular steel frame finished in Off Black powder coat  
 — Footrest protector  
 — Plastic glides

Optional Features:  
 — Plastic glides with felt  
 — Counter height stool option, seat height 625mm (add CH to product code)  
 — Multi-Fabrics



For larger swatches go to pg.172-174



↓ Scan here to discover more



# Kin

Design by Pearson Lloyd

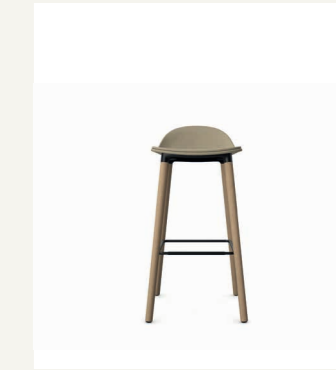
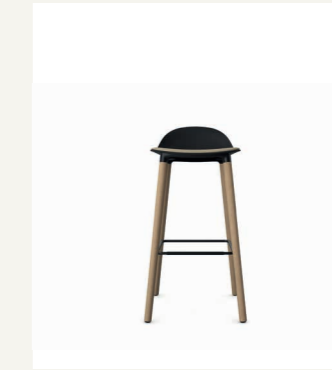
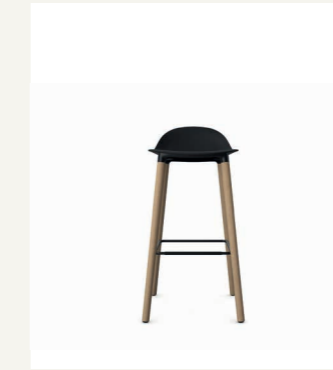

**Kin - KIN503**  
Low back stool on wood legs

Dimensions:  
 Seat Height 745mm  
 Seat Width 410mm  
 Seat Depth 375mm  
 Overall Height 880mm  
 Overall Width 445mm  
 Overall Depth 480mm

Standard Features:  
 — Plastic shell finished in Off Black  
 — Aluminium leg connector frame and footrest finished in Off Black powder coat  
 — Solid Ash legs with a clear finish  
 — Footrest protector  
 — Plastic glides

Optional Features:  
 — Plastic shell available in a selection of colours with complementary powder coat base or frame  
 — Solid Ash legs can be stained or colour matched to complement shell  
 — Plastic glides with felt

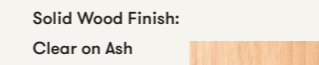

For larger swatches go to pg.172-176

6 optional Wood Stains and 8 colour washes based on Ash are also available please go to pg.177 and 178 to see more.



**Kin - KIN503U1**  
Low back stool with upholstered seat on wood legs

Dimensions:  
 Seat Height 745mm  
 Seat Width 410mm  
 Seat Depth 375mm  
 Overall Height 880mm  
 Overall Width 445mm  
 Overall Depth 480mm

Standard Features:  
 — Plastic shell finished in Off Black  
 — Upholstered seat pad  
 — Aluminium leg connector frame and footrest finished in Off Black powder coat  
 — Solid Ash legs with a clear finish  
 — Footrest protector  
 — Plastic glides

Optional Features:  
 — Plastic shell available in a selection of colours with complementary powder coat base or frame  
 — Solid Ash legs can be stained or colour matched to complement shell  
 — Plastic glides with felt

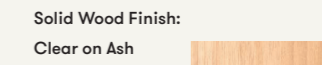

For larger swatches go to pg.172-176

6 optional Wood Stains and 8 colour washes based on Ash are also available please go to pg.177 and 178 to see more.



**Kin - KIN503U3**  
Fully upholstered low back stool on wood legs

Dimensions:  
 Seat Height 745mm  
 Seat Width 410mm  
 Seat Depth 375mm  
 Overall Height 880mm  
 Overall Width 445mm  
 Overall Depth 480mm

Standard Features:  
 — Fully upholstered shell  
 — Aluminium leg connector frame and footrest finished in Off Black powder coat  
 — Solid Ash legs with a clear finish  
 — Footrest protector  
 — Plastic glides

Optional Features:  
 — Solid Ash legs can be stained or colour matched to complement shell  
 — Plastic glides with felt  
 — Multi-Fabrics



For larger swatches go to pg.172-176

6 optional Wood Stains and 8 colour washes based on Ash are also available please go to pg.177 and 178 to see more.



# Kin

Design by Pearson Lloyd

44

45

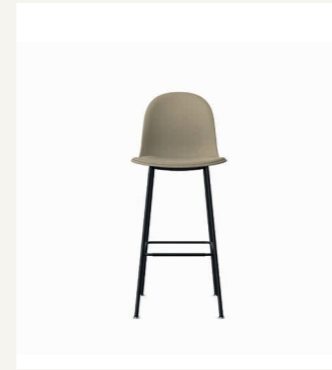
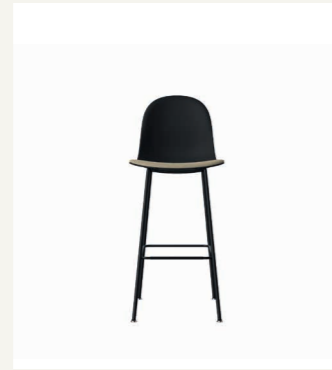
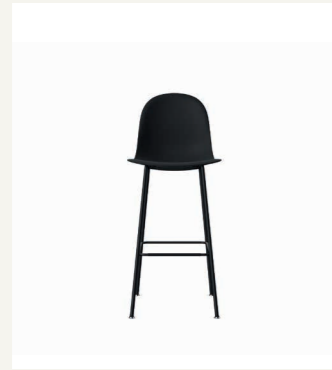

**Kin - KIN602**  
High back stool on 4 leg frame

Dimensions:  
Seat Height 745mm  
Seat Width 460mm  
Seat Depth 475mm  
Overall Height 1115mm  
Overall Width 460mm  
Overall Depth 535mm

Standard Features:  
— Plastic shell finished in Off Black  
— Tubular steel frame finished in Off Black powder coat  
— Footrest protector  
— Plastic glides

Optional Features:  
— Plastic shell available in a selection of colours with complementary powder coat base or frame  
— Plastic glides with felt  
— Counter height stool option, seat height 625mm (add CH to product code)



For larger swatches go to pg.172-174

**Kin - KIN602U1**  
High back stool with upholstered seat on 4 leg frame

Dimensions:  
Seat Height 745mm  
Seat Width 460mm  
Seat Depth 475mm  
Overall Height 1115mm  
Overall Width 460mm  
Overall Depth 535mm

Standard Features:  
— Plastic shell finished in Off Black  
— Upholstered seat pad  
— Tubular steel frame finished in Off Black powder coat  
— Footrest protector  
— Plastic glides

Optional Features:  
— Plastic shell available in a selection of colours with complementary powder coat base or frame  
— Plastic glides with felt  
— Counter height stool option, seat height 625mm (add CH to product code)



For larger swatches go to pg.172-174

**Kin - KIN602U3**  
Fully upholstered high back stool with 4 leg frame

Dimensions:  
Seat Height 745mm  
Seat Width 460mm  
Seat Depth 475mm  
Overall Height 1115mm  
Overall Width 460mm  
Overall Depth 535mm

Standard Features:  
— Fully upholstered shell  
— Tubular steel frame finished in Off Black powder coat  
— Footrest protector  
— Plastic glides

Optional Features:  
— Plastic shell available in a selection of colours with complementary powder coat base or frame  
— Plastic glides with felt  
— Counter height stool option, seat height 625mm (add CH to product code)  
— Multi-Fabrics



For larger swatches go to pg.172-174



↓ Scan here to discover more



↓ Scan here to discover more



# Mollie

Design by John Coleman

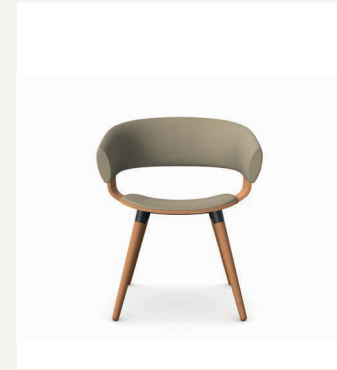
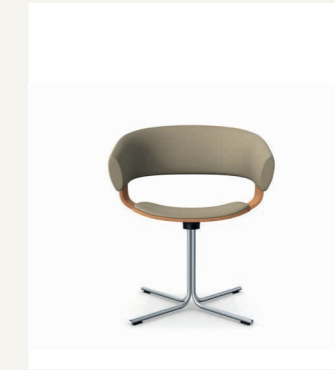
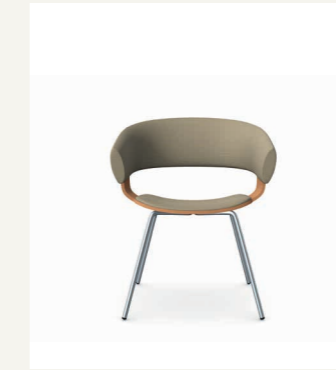

**Mollie - A680**  
Chair on a 4 leg frame

Dimensions:  
Seat Height 460mm  
Seat Width 435mm  
Seat Depth 410mm  
Overall Height 740mm  
Overall Width 610mm  
Overall Depth 545mm

Standard Features and Finishes:  
— Tubular Steel frame in Silver M04 powder coat with a Beech shell in a clear finish as standard  
— Upholstered seat and back  
— Plastic glides

Optional Features:  
— Polished Chrome frame finish  
— Beech Shell can be stained or colour washed  
— Oak / Walnut veneer shell with a clear finish  
— Plastic glides with felt  
— Multi-Fabrics

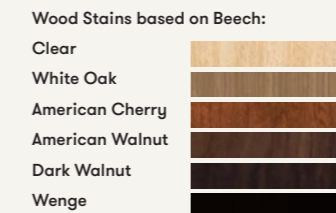
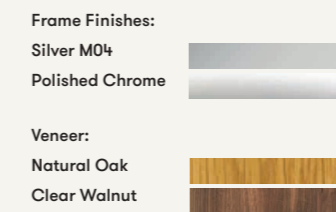

For larger swatches go to pg.172-177

16 optional Beech colour washes are also available please go to pg. 178 to see more.



**Mollie - A681**  
Chair on a swivel base

Dimensions:  
Seat Height 460mm  
Seat Width 435mm  
Seat Depth 410mm  
Overall Height 740mm  
Overall Width 610mm  
Overall Depth 545mm

Standard Features and Finishes:  
— Tubular Steel frame in Silver M04 powder coat with a Beech shell in a clear finish as standard  
— Upholstered seat and back  
— Plastic glides

Optional Features:  
— Polished Chrome frame finish  
— Beech Shell can be stained or colour washed  
— Oak / Walnut veneer shell with a clear finish  
— Multi-Fabrics

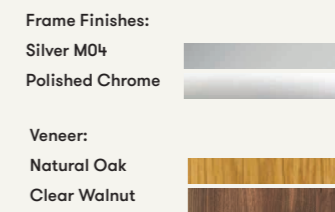

For larger swatches go to pg.172-177

16 optional Beech colour washes are also available please go to pg. 178 to see more.



**Mollie - A685**  
Chair on a 4 leg wood

Dimensions:  
Seat Height 460mm  
Seat Width 435mm  
Seat Depth 410mm  
Overall Height 755mm  
Overall Width 610mm  
Overall Depth 545mm

Standard Features and Finishes:  
— Beech shell and conical legs in a clear finish  
— Aluminium leg connector frame finished in Dark Silver powder coat  
— Upholstered seat and back  
— Plastic glides

Optional Features:  
— Beech Shell and Legs can be stained or colour washed  
— Oak / Walnut veneer shell with a clear finish  
— Solid Oak legs with a clear finish  
— Aluminium leg connector frame finished in Black powder coat  
— Multi-Fabrics

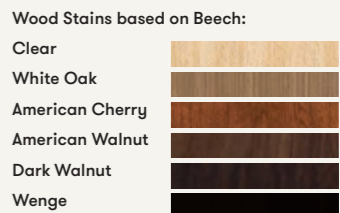
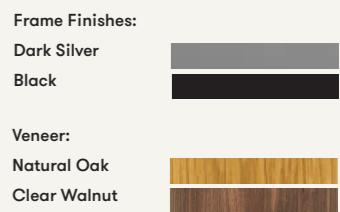

For larger swatches go to pg.172-177

16 optional Beech colour washes are also available please go to pg. 178 to see more.



# Mollie

Design by John Coleman

46

47

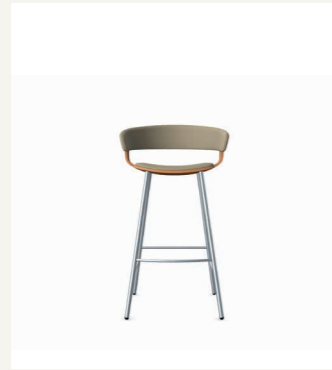
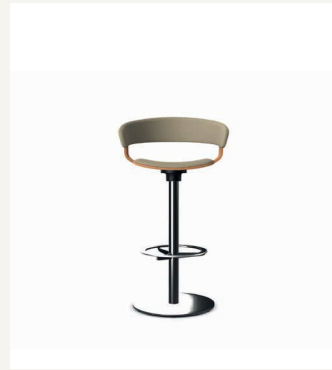

## Mollie - A582 Stool on swivel pedestal base





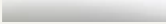

Dimensions:  
Seat Height 750mm  
Seat Width 400mm  
Seat Depth 440mm  
Overall Height 1000mm  
Overall Width 560mm  
Overall Depth 500mm

- Standard Features:
- Beech shell in a clear finish
  - Steel swivel pedestal base and footring finished in Polished Chrome
  - Upholstered seat and back
  - Plastic glides

- Optional Features:
- Beech shell can be stained or colour washed
  - Multi-Fabrics
  - Counter height stool option, seat height 625mm (add CH to product code)

Frame Finishes:  
Polished Chrome 

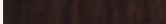
Wood Stains based on Beech:

Clear	
White Oak	
American Cherry	
American Walnut	
Dark Walnut	
Wenge	

For larger swatches go to pg.172-177

16 optional Beech colour washes are also available please go to pg. 178 to see more.



## Mollie - A583 Stool on 4 leg frame





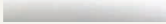
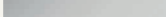

Dimensions:  
Seat Height 750mm  
Seat Width 400mm  
Seat Depth 440mm  
Overall Height 1000mm  
Overall Width 560mm  
Overall Depth 500mm

- Standard Features:
- Beech shell with a clear finish
  - Tubular steel frame finished in Silver M04
  - Upholstered seat and back
  - Plastic glides

- Optional Features:
- Polished Chrome frame finish
  - Beech shell can be stained or colour washed
  - Plastic glides with felt
  - Multi-Fabrics
  - Counter height stool option, seat height 625mm (add CH to product code)

Frame Finishes:  
Polished Chrome   
Silver M04 

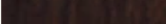
Wood Stains based on Beech:

Clear	
White Oak	
American Cherry	
American Walnut	
Dark Walnut	
Wenge	

For larger swatches go to pg.172-177

16 optional Beech colour washes are also available please go to pg. 178 to see more.

## Mollie - A584 Stool on height adjustable base







Dimensions:  
Seat Height 670mm  
Seat Width 400mm  
Seat Depth 440mm  
Overall Height 920mm  
Overall Width 560mm  
Overall Depth 500mm

- Standard Features:
- Beech shell with a clear finish
  - Height adjustable Steel swivel pedestal base finished in Polished Chrome
  - Upholstered seat and back
  - Plastic glides

- Optional Features:
- Beech shell can be stained or colour washed
  - Multi-Fabrics

Frame Finishes:  
Polished Chrome 

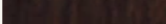
Wood Stains based on Beech:

Clear	
White Oak	
American Cherry	
American Walnut	
Dark Walnut	
Wenge	

For larger swatches go to pg.172-177

16 optional Beech colour washes are also available please go to pg. 178 to see more.

↓ Scan here to discover more



↓ Scan here to discover more



# Ooty

Design by SmithMatthias

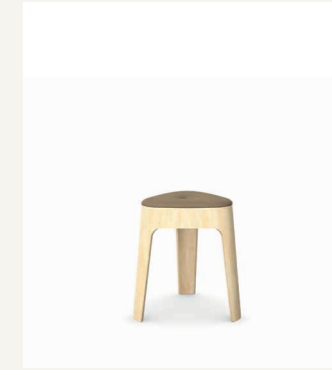
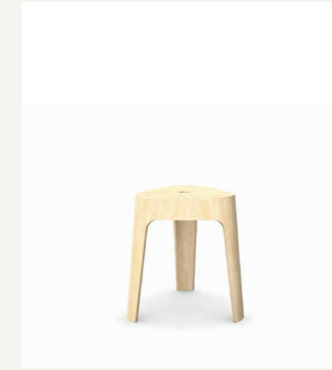

## Ooty - OTY01 Stool





Dimensions:  
Seat Height 445mm  
Seat Width 330mm  
Seat Depth 330mm  
Overall Height 445mm  
Overall Width 430mm  
Overall Depth 430mm

- Standard Features:
- Ash veneered plywood frame with a clear finish
  - Stacks up to 6 high

- Optional Features:
- Ash veneered plywood frame can be colour washed

Veneer:  
Plywood Clear 

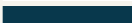
Colour Washes based on Ash:

Back to Black	
White	
Peacock Blue	
Coral	
Haze Blue	

For larger swatches go to pg.176-178



## Ooty - OTYU1 Stool with cushion

Dimensions:  
Seat Height 470mm  
Seat Width 330mm  
Seat Depth 330mm  
Overall Height 470mm  
Overall Width 430mm  
Overall Depth 430mm

- Standard Features:
- Ash veneer plywood frame
  - Upholstered seat pad in Kvadrat Melange Nap
  - Stacks up to 6 high





- Optional Features:
- Ash veneered plywood frame can be colour washed

Veneer:  
Plywood Clear 

Colour Washes based on Ash:

Back to Black	
White	
Peacock Blue	
Coral	
Haze Blue	

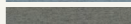
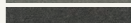
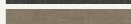
Seat Pad:

Melange Nap 951	
Melange Nap 521	
Melange Nap 711	
Melange Nap 111	
Melange Nap 271	
Melange Nap 211	
Melange Nap 191	

For larger swatches go to pg.176-178





# Phoulds – Wood Shell

Design by Allermuir Design Studio

48

49

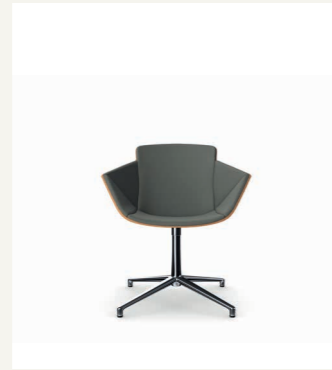
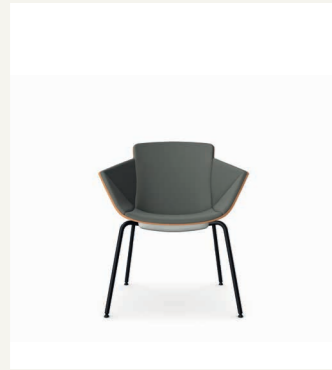

**Phoulds - PH1**  
Medium back chair with wood shell on 4 leg frame

Dimensions:

Seat Height	450mm
Seat Width	385mm
Seat Depth	435mm
Overall Height	770mm
Overall Width	680mm
Overall Depth	595mm

- Standard Features:
- 6 panel upholstery with CMHR foam
  - Beech shell with a clear finish
  - Plastic under seat shroud
  - Tubular Steel frame finished in Polished Chrome with self-levelling glides

- Optional Features:
- Tubular Steel frame available in Black powder coat
  - Beech shell can be stained or colour washed
  - Walnut veneer shell with a clear finish
  - Plastic self-levelling glides with felt
  - Multi-Fabrics

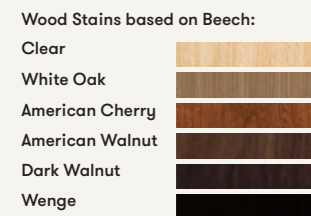
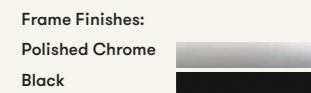

For larger swatches go to pg.172-177

16 optional Beech colour washes are also available please go to pg. 178 to see more.



**Phoulds - PH2**  
Medium back chair with wood shell on 4 star base

Dimensions:

Seat Height	450mm
Seat Width	385mm
Seat Depth	435mm
Overall Height	770mm
Overall Width	725mm
Overall Depth	725mm

- Standard Features:
- 6 panel upholstery with CMHR foam
  - Beech shell with a clear finish
  - 4-star Polished Aluminium base with plastic glides

- Optional Features:
- Beech shell can be stained or colour washed
  - Walnut veneer shell with a clear finish
  - Multi-Fabrics

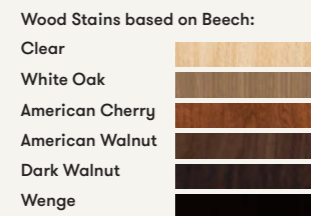
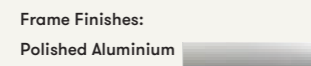

For larger swatches go to pg.172-177

16 optional Beech colour washes are also available please go to pg. 178 to see more.



**Phoulds - PH7**  
Medium back chair with wood shell on 5 star base and casters

Dimensions:

Seat Height	450mm
Seat Width	385mm
Seat Depth	435mm
Overall Height	770mm
Overall Width	680mm
Overall Depth	680mm

- Standard Features:
- 6 panel upholstery with CMHR foam
  - Beech shell with a clear finish
  - 5-star Polished Aluminium base with casters
  - Seat height adjustment

- Optional Features:
- Beech shell can be stained or colour washed
  - Walnut veneer shell with a clear finish
  - Multi-Fabrics

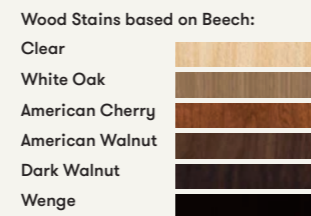
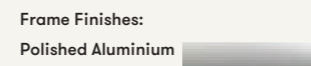

For larger swatches go to pg.172-177

16 optional Beech colour washes are also available please go to pg. 178 to see more.



↓ Scan here to discover more



↓ Scan here to discover more



# Phoulds – Wood Shell

Design by Allermuir Design Studio

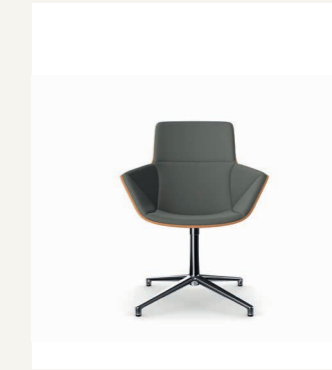
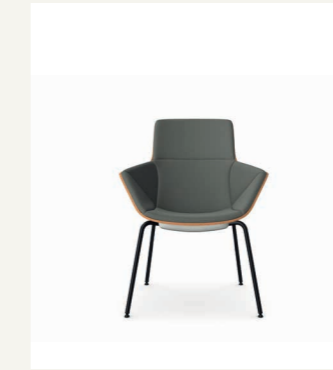

**Phoulds - PH3**  
High back chair with wood shell on 4 leg frame

Dimensions:

Seat Height	450mm
Seat Width	385mm
Seat Depth	435mm
Overall Height	895mm
Overall Width	725mm
Overall Depth	640mm

- Standard Features:
- 6 panel upholstery with CMHR foam
  - Beech shell with a clear finish
  - Plastic under seat shroud
  - Tubular Steel frame finished in Polished Chrome with self-leveling glides

- Optional Features:
- Tubular Steel frame available in Black powder coat
  - Beech shell can be stained or colour washed
  - Walnut veneer shell with a clear finish
  - Plastic self leveling glides with felt
  - Multi-Fabrics

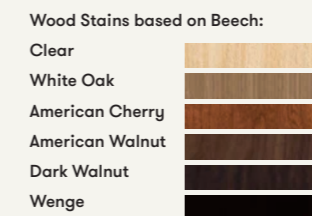
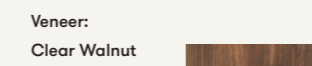
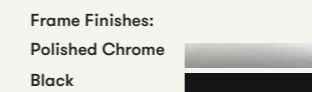

For larger swatches go to pg.172-177

16 optional Beech colour washes are also available please go to pg. 178 to see more.



**Phoulds - PH4**  
High back chair with wood shell on 4 star base

Dimensions:

Seat Height	450mm
Seat Width	385mm
Seat Depth	435mm
Overall Height	895mm
Overall Width	725mm
Overall Depth	640mm

- Standard Features:
- 6 panel upholstery with CMHR foam
  - Beech shell with a clear finish
  - Plastic under seat shroud
  - 4-star Polished Aluminium base with casters

- Optional Features:
- Beech shell can be stained or colour washed
  - Walnut veneer shell with a clear finish
  - Multi-Fabrics

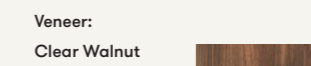
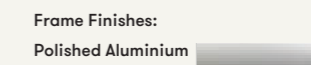

For larger swatches go to pg.172-177

16 optional Beech colour washes are also available please go to pg. 178 to see more.



**Phoulds - PH8**  
High back chair with wood shell on 5 star base and casters

Dimensions:

Seat Height	450mm
Seat Width	385mm
Seat Depth	435mm
Overall Height	895mm
Overall Width	680mm
Overall Depth	700mm

- Standard Features:
- 6 panel upholstery with CMHR foam
  - Beech shell with a clear finish
  - 5-star Polished Aluminium base with casters
  - Seat height adjustment

- Optional Features:
- Beech shell can be stained or colour washed
  - Walnut veneer shell with a clear finish
  - Multi-Fabrics

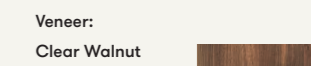
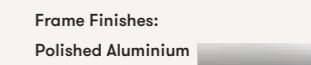

For larger swatches go to pg.172-177

16 optional Beech colour washes are also available please go to pg. 178 to see more.



# Phoulds – Upholstered

Design by Allermuir Design Studio

60

61

# Phoulds – Upholstered

Design by Allermuir Design Studio

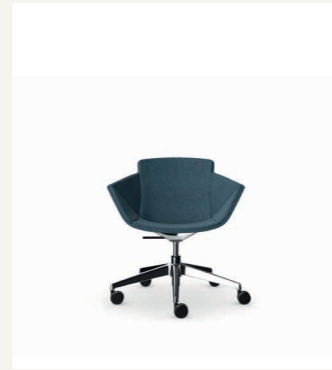
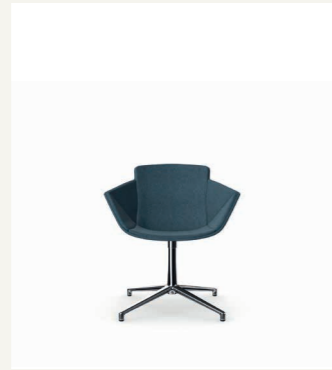
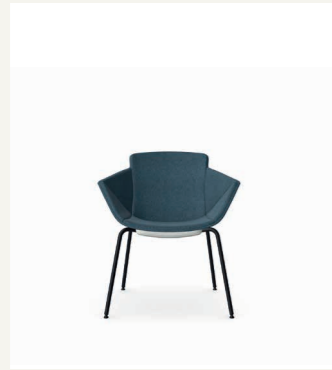

**Phoulds - PH1U**  
Medium back 4 leg chair with upholstered shell

**Dimensions:**

Seat Height	450mm
Seat Width	385mm
Seat Depth	435mm
Overall Height	770mm
Overall Width	680mm
Overall Depth	595mm

**Standard Features:**

- 6 Panel upholstery with CMHR foam
- Fully upholstered outer shell
- Plastic under seat shroud
- Tubular steel frame finished in polished chrome with self-levelling glides

**Optional Features:**

- Tubular Steel frame available in Black powder coat
- Plastic self-levelling glides with felt
- Multi-Fabrics

**Frame Finishes:**



For larger swatches go to pg.172-173

**Phoulds - PH2U**  
Medium back 4 star base chair with upholstered shell

**Dimensions:**

Seat Height	450mm
Seat Width	385mm
Seat Depth	435mm
Overall Height	770mm
Overall Width	725mm
Overall Depth	725mm

**Standard Features:**

- 6 panel upholstery with CMHR foam
- Fully upholstered outer shell
- 4-Star polished Aluminium base with felt glides

**Optional Features:**

- Multi-Fabrics

**Base Finish:**

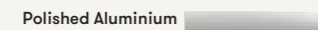

For larger swatches go to pg.172-173

**Phoulds - PH7U**  
Medium back 5 star base chair on casters with upholstered shell

**Dimensions:**

Seat Height	450mm
Seat Width	385mm
Seat Depth	435mm
Overall Height	770mm
Overall Width	680mm
Overall Depth	680mm

**Standard Features:**

- 6 panel upholstery with CMHR foam
- Fully upholstered outer shell
- 5-star Polished Aluminium base with casters
- Seat height adjustment

**Optional Features:**

- Multi-Fabrics

**Base Finish:**

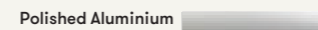

For larger swatches go to pg.172-173



↓ Scan here to discover more



↓ Scan here to discover more

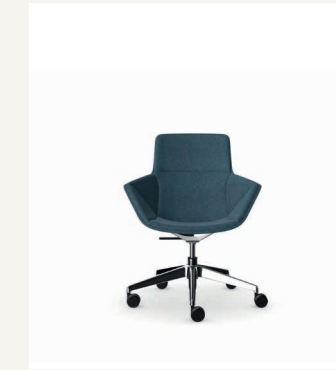
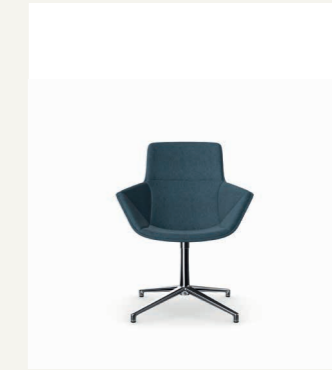
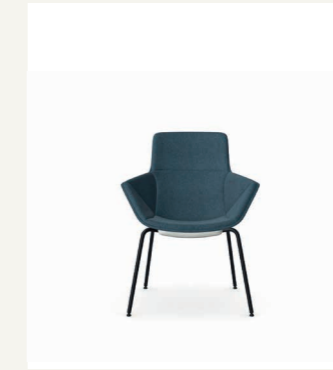

**Phoulds - PH3U**  
High back 4 leg chair with upholstered shell frame

**Dimensions:**

Seat Height	450mm
Seat Width	385mm
Seat Depth	435mm
Overall Height	895mm
Overall Width	725mm
Overall Depth	640mm

**Standard Features:**

- 6 panel upholstery with CMHR foam
- Fully upholstered outer shell
- Plastic under seat shroud
- Tubular Steel frame finished in Polished Chrome with self-levelling glides

**Optional Features:**

- Tubular Steel frame available in Black powder coat
- Plastic self-levelling glides with felt
- Multi-Fabrics

**Frame Finishes:**



For larger swatches go to pg.172-173

**Phoulds - PH4U**  
High back 4 star base chair with upholstered shell

**Dimensions:**

Seat Height	450mm
Seat Width	385mm
Seat Depth	435mm
Overall Height	895mm
Overall Width	725mm
Overall Depth	725mm

**Standard Features:**

- 6 panel upholstery with CMHR foam
- Fully upholstered outer shell
- 4 star polished Aluminium base with felt guides

**Optional Features:**

- Multi-Fabrics

**Frame Finishes:**

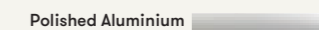

For larger swatches go to pg.172-173

**Phoulds - PH8U**  
High back chair with upholstered shell on a 5 star base with casters

**Dimensions:**

Seat Height	450mm
Seat Width	385mm
Seat Depth	435mm
Overall Height	895mm
Overall Width	680mm
Overall Depth	700mm

**Standard Features:**

- 6 panel upholstery with CMHR foam
- Fully upholstered outer shell
- 5-star Polished Aluminium base with casters
- Seat height adjustment

**Optional Features:**

- Multi-Fabrics

**Frame Finishes:**

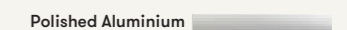

For larger swatches go to pg.172-173



# Phoulds – Quilted

Design by Allermuir Design Studio

52

53

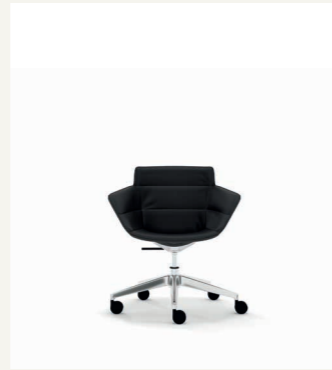
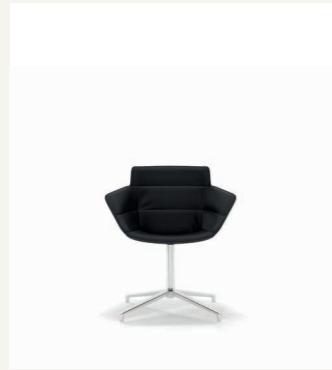
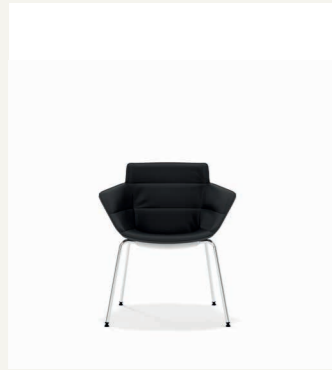

**Phoulds - PH11U**  
Medium back 4 leg chair with soft quilted upholstery

**Dimensions:**

Seat Height	450mm
Seat Width	385mm
Seat Depth	435mm
Overall Height	770mm
Overall Width	680mm
Overall Depth	595mm

**Standard Features:**

- Soft quilted upholstery
- Fully upholstered outer shell
- Plastic under seat shroud
- Tubular steel frame finished in Polished Chrome with self-levelling glides

**Optional Features:**

- Tubular Steel frame available in Black powder coat
- Plastic self-levelling glides with felt
- Multi-Fabrics

**Frame Finishes:**

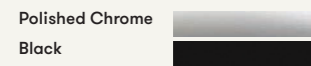

For larger swatches go to pg.172-173

**Phoulds - PH12U**  
Medium back 4- Star base chair with soft quilted upholstery

**Dimensions:**

Seat Height	450mm
Seat Width	385mm
Seat Depth	435mm
Overall Height	770mm
Overall Width	725mm
Overall Depth	725mm

**Standard Features:**

- Soft quilted upholstery
- Fully upholstered outer shell
- 4-Star Polished Aluminium base with felt glides

**Optional Features:**

- Multi-Fabrics

**Frame Finishes:**

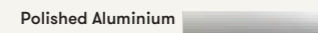

For larger swatches go to pg.172-173

**Phoulds - PH17U**  
Medium back 5- Star base chair on casters with soft quilted upholstery

**Dimensions:**

Seat Height	450mm
Seat Width	385mm
Seat Depth	435mm
Overall Height	770mm
Overall Width	680mm
Overall Depth	680mm

**Standard Features:**

- Soft quilted upholstery
- Fully upholstered outer shell
- 5-star Polished Aluminium base with casters
- Seat height adjustment

**Optional Features:**

- Multi-Fabrics

**Frame Finishes:**

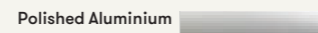

For larger swatches go to pg.172-173



↓ Scan here to discover more



↓ Scan here to discover more



# Phoulds – Quilted

Design by Allermuir Design Studio

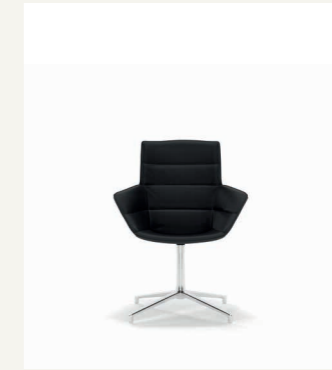
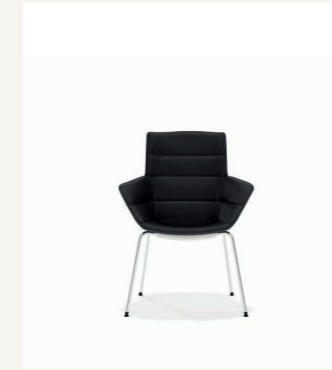

**Phoulds - PH13U**  
High back 4 leg chair with soft quilted upholstery

**Dimensions:**

Seat Height	450mm
Seat Width	385mm
Seat Depth	435mm
Overall Height	895mm
Overall Width	725mm
Overall Depth	640mm

**Standard Features:**

- Soft quilted upholstery
- Fully upholstered outer shell
- Plastic under seat shroud
- Tubular Steel frame finished in Polished Chrome with self-levelling glides

**Optional Features:**

- Tubular Steel frame available in Black powder coat
- Plastic self-levelling glides with felt
- Multi-Fabrics

**Frame Finishes:**



For larger swatches go to pg.172-173

**Phoulds - PH14U**  
High back 4- Star base chair with soft quilted upholstery

**Dimensions:**

Seat Height	450mm
Seat Width	385mm
Seat Depth	435mm
Overall Height	895mm
Overall Width	725mm
Overall Depth	725mm

**Standard Features:**

- Soft quilted upholstery
- Fully upholstered outer shell
- Plastic under seat shroud
- 4-Star polished Aluminium base with felt guides

**Optional Features:**

- Multi-Fabrics

**Frame Finishes:**

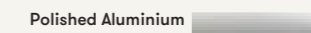

For larger swatches go to pg.172-173

**Phoulds - PH18U**  
High back 5- Star base chair on casters with soft quilted upholstery

**Dimensions:**

Seat Height	450mm
Seat Width	385mm
Seat Depth	435mm
Overall Height	895mm
Overall Width	680mm
Overall Depth	700mm

**Standard Features:**

- Soft quilted upholstery
- Fully upholstered outer shell
- 5-star Polished Aluminium base with casters
- Seat height adjustment

**Optional Features:**

- Multi-Fabrics

**Frame Finishes:**

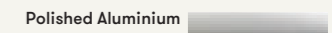

For larger swatches go to pg.172-173



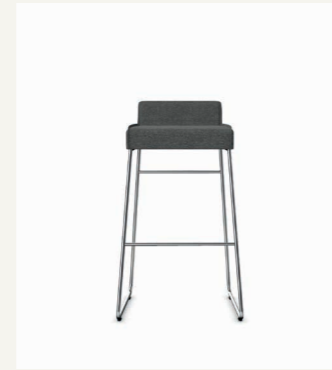
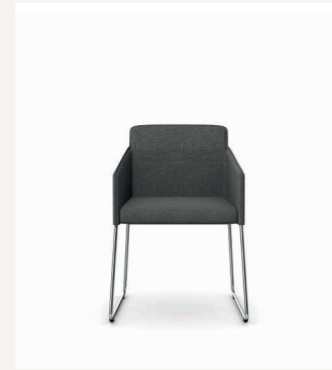
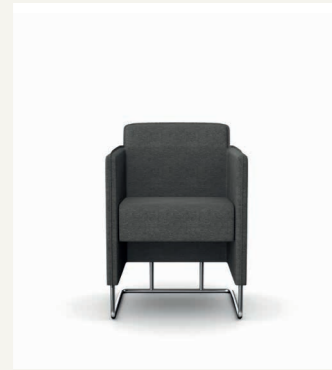

**Tommo - A530**  
Club chair

Dimensions:  
 Seat Height 480mm  
 Seat Width 490mm  
 Seat Depth 460mm  
 Overall Height 800mm  
 Overall Width 560mm  
 Overall Depth 570mm

- Standard Features:
- Traditional carcass construction
  - Fully upholstered
  - Tubular Steel frame finished in Polished Chrome

- Optional Features:
- Multi-Fabrics

Frame Finishes:  
 Polished Chrome

For larger swatches go to pg.172-173

**Tommo - A532**  
Dining chair

Dimensions:  
 Seat Height 480mm  
 Seat Width 470mm  
 Seat Depth 450mm  
 Overall Height 790mm  
 Overall Width 560mm  
 Overall Depth 550mm

- Standard Features:
- Traditional carcass construction
  - Fully upholstered
  - Tubular Steel frame finished in Polished Chrome
  - Plastic glides

- Optional Features:
- Multi-Fabrics

Frame Finishes:  
 Polished Chrome

For larger swatches go to pg.172-173

**Tommo - A534**  
High stool

Dimensions:  
 Seat Height 750mm  
 Seat Width 410mm  
 Seat Depth 400mm  
 Overall Height 830mm  
 Overall Width 480mm  
 Overall Depth 480mm

- Standard Features:
- Traditional carcass construction
  - Fully upholstered
  - Tubular Steel frame finished in Polished Chrome
  - Plastic glides

- Optional Features:
- Multi-Fabrics
  - Counter height stool option, seat height 625mm (add CH to product code)

Frame Finishes:  
 Polished Chrome

For larger swatches go to pg.172-173

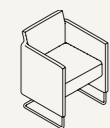

↓ Scan here to discover more



↓ Scan here to discover more

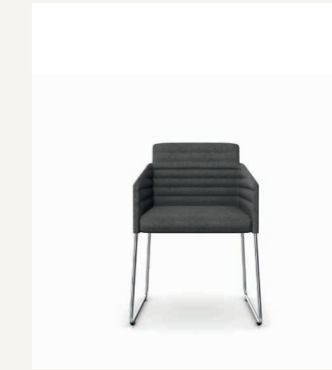
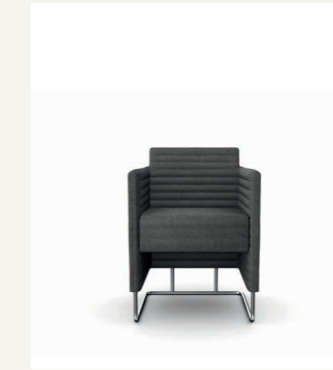

**Tommo - A530Q**  
Club chair

Dimensions:  
 Seat Height 480mm  
 Seat Width 490mm  
 Seat Depth 460mm  
 Overall Height 800mm  
 Overall Width 560mm  
 Overall Depth 570mm

- Standard Features:
- Traditional carcass construction
  - Fully upholstered
  - Soft Quilted Upholstery
  - Tubular Steel frame finished in Polished Chrome

- Optional Features:
- Multi-Fabrics

Frame Finishes:  
 Polished Chrome

For larger swatches go to pg.172-173

**Tommo - A532Q**  
Dining chair

Dimensions:  
 Seat Height 480mm  
 Seat Width 470mm  
 Seat Depth 450mm  
 Overall Height 790mm  
 Overall Width 560mm  
 Overall Depth 550mm

- Standard Features:
- Traditional carcass construction
  - Fully upholstered
  - Soft Quilted Upholstery
  - Tubular Steel frame finished in Polished Chrome
  - Plastic glides

- Optional Features:
- Multi-Fabrics

Frame Finishes:  
 Polished Chrome

For larger swatches go to pg.172-173

**Tommo - A534Q**  
High stool

Dimensions:  
 Seat Height 750mm  
 Seat Width 410mm  
 Seat Depth 400mm  
 Overall Height 830mm  
 Overall Width 480mm  
 Overall Depth 480mm

- Standard Features:
- Traditional carcass construction
  - Fully upholstered
  - Soft Quilted Upholstery
  - Tubular Steel frame finished in Polished Chrome
  - Plastic glides

- Optional Features:
- Multi-Fabrics
  - Counter height stool option, seat height 625mm (add CH to product code)

Frame Finishes:  
 Polished Chrome

For larger swatches go to pg.172-173

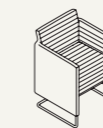



## Contents

060	Conic
062	Famiglia
067	Fifty Series
070	Grainger
072	Haven
074	Haven Bench
076	Jinx
077	Lola
079	Mayze Mobile
080	Mozaik
082	Open
084	Pause
087	Pebble
088	Plum
092	Qu
093	Tarry
094	Tylus & Cushions
096	Venus

# Conic

Design by Pearson Lloyd

60

61

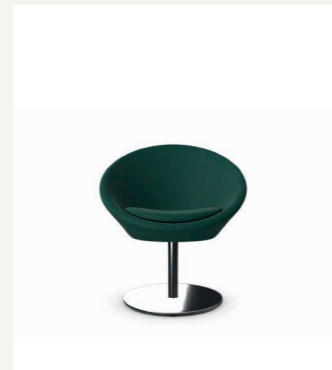
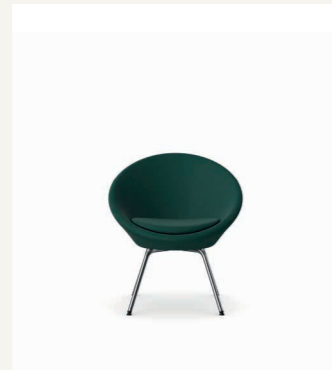
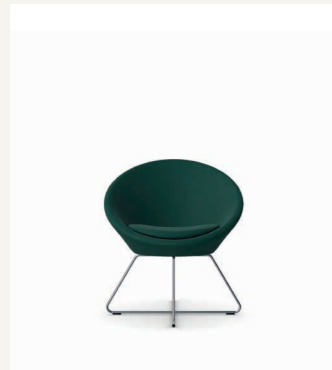

**Conic - A630**  
Tub chair on a wire frame

**Dimensions:**

Seat Height	490mm
Seat Width	470mm
Seat Depth	480mm
Overall Height	810mm
Overall Width	780mm
Overall Depth	660mm

**Standard Features:**

- Moulded foam construction
- Fully upholstered
- Wire frame finished in Polished Chrome
- Plastic glides

**Optional Features:**

- Wire frame available in a selection of powder coat finishes
- Multi-Fabrics
- Decorative Railroad Stitch Detail in Black, White, Red, Light Grey, Dark Grey or Cream

**Frame Finishes:**

Polished Chrome	
New Black	
White	
Soft Gold	
Soft Silver	
Dark Bronze	
Deep Mulberry	

For larger swatches go to pg.172-173

**Conic - A637**  
Tub chair on 1/4 leg frame

**Dimensions:**

Seat Height	490mm
Seat Width	470mm
Seat Depth	480mm
Overall Height	810mm
Overall Width	780mm
Overall Depth	660mm

**Standard Features:**

- Moulded foam construction
- Fully upholstered
- Tubular Steel frame finished in Polished Aluminium
- Plastic self-levelling glides

**Optional Features:**

- Tubular Steel frame available in a selection of powder coat finishes
- Plastic self-levelling glides with felt
- Multi-Fabrics
- Decorative Railroad Stitch Detail in Black, White, Red, Light Grey, Dark Grey or Cream

**Frame Finishes:**

Polished Chrome	
New Black	
White	
Soft Gold	
Soft Silver	
Dark Bronze	
Deep Mulberry	

For larger swatches go to pg.172-173

**Conic - A633**  
Tub chair with pedestal base

**Dimensions:**

Seat Height	490mm
Seat Width	470mm
Seat Depth	480mm
Overall Height	810mm
Overall Width	780mm
Overall Depth	660mm

**Standard Features:**

- Moulded foam construction
- Fully upholstered
- Steel swivel pedestal base finished in Polished Chrome
- Plastic glides

**Optional Features:**

- Multi-Fabrics
- Decorative Railroad Stitch Detail in Black, White, Red, Light Grey, Dark Grey or Cream

**Frame Finishes:**

Polished Chrome	
-----------------	--

For larger swatches go to pg.172-173



↓ Scan here to discover more



↓ Scan here to discover more



# Conic

Design By Pearson Lloyd



**Conic - A631**  
Lounge chair on a wire frame

**Dimensions:**

Seat Height	480mm
Seat Width	540mm
Seat Depth	520mm
Overall Height	750mm
Overall Width	900mm
Overall Depth	800mm

**Standard Features:**

- Moulded foam construction
- Fully upholstered
- Wire frame finished in Polished Chrome
- Plastic glides

**Optional Features:**

- Wire frame available in a selection of powder coat finishes
- Multi-Fabrics
- Decorative Railroad Stitch Detail in Black, White, Red, Light Grey, Dark Grey or Cream

**Frame Finishes:**

Polished Chrome	
New Black	
White	
Soft Gold	
Soft Silver	
Dark Bronze	
Deep Mulberry	

For larger swatches go to pg.172-173

**Conic - A632**  
Lounge chair with integral headrest

**Dimensions:**

Seat Height	470mm
Seat Width	540mm
Seat Depth	520mm
Overall Height	1050mm
Overall Width	900mm
Overall Depth	810mm

**Standard Features:**

- Moulded foam construction
- Fully upholstered
- Wire frame finished in Polished Chrome
- Plastic glides

**Optional Features:**

- Wire frame available in a selection of powder coat finishes
- Multi-Fabrics
- Decorative Railroad Stitch Detail in Black, White, Red, Light Grey, Dark Grey or Cream

**Frame Finishes:**

Polished Chrome	
New Black	
White	
Soft Gold	
Soft Silver	
Dark Bronze	
Deep Mulberry	

For larger swatches go to pg.172-173



# Famiglia

Design by Pearson Lloyd

62

63

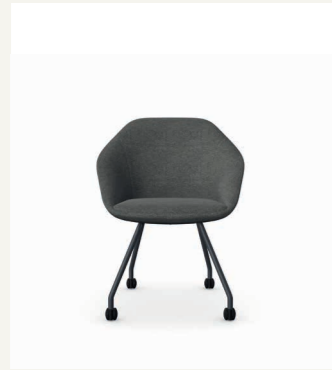

**Famiglia - FMG1101**  
Low back on a 4 leg frame with casters

Dimensions:

Seat Height	475mm
Seat Width	450mm
Seat Depth	450mm
Overall Height	820mm
Overall Width	640mm
Overall Depth	595mm

- Standard Features:
- Moulded foam construction
  - Fully Upholstered
  - Tubular Steel Frame on 50mm hard wheel casters finished in New Black powder coat
  - 50mm hard wheel casters

- Optional Features:
- Tubular Steel frame available in a selection of powder coat finishes
  - 50mm soft wheels casters
  - Multi-Fabrics

Frame Finishes:

New Black	
White	
Soft Gold	
Soft Silver	
Dark Bronze	
Deep Mulberry	

For larger swatches go to pg.172-173

**Famiglia - FMG1102**  
Low back chair on a 4 leg frame

Dimensions:

Seat Height	450mm
Seat Width	450mm
Seat Depth	450mm
Overall Height	795mm
Overall Width	640mm
Overall Depth	595mm

- Standard Features:
- Moulded foam construction
  - Fully Upholstered
  - Tubular Steel Frame finished in New Black powder coat
  - Plastic Glides

- Optional Features:
- Tubular Steel frame available in a selection of powder coat finishes
  - Plastic Glides with felt
  - Multi-Fabrics

Frame Finishes:

New Black	
White	
Soft Gold	
Soft Silver	
Dark Bronze	
Deep Mulberry	

For larger swatches go to pg.172-173

**Famiglia - FMG1103**  
Low back chair on wood legs

Dimensions:

Seat Height	455mm
Seat Width	450mm
Seat Depth	450mm
Overall Height	805mm
Overall Width	640mm
Overall Depth	595mm

- Standard Features:
- Moulded foam construction
  - Fully Upholstered
  - Aluminium leg connector frame finished in New Black powder coat
  - Solid Ash legs with a clear finish
  - Plastic Glides

- Optional Features:
- Solid Ash legs can be stained or colour washed
  - Plastic Glides with felt
  - Multi-Fabrics

Frame Finishes:

New Black	
Wood Stains based on Ash:	
Clear	
White Oak	
American Cherry	
American Walnut	
Dark Walnut	
Wenge	

For larger swatches go to pg.172-177

16 optional Ash colour washes are also available please go to pg. 178 to see more.



↓ Scan here to discover more



↓ Scan here to discover more



# Famiglia

Design by Pearson Lloyd

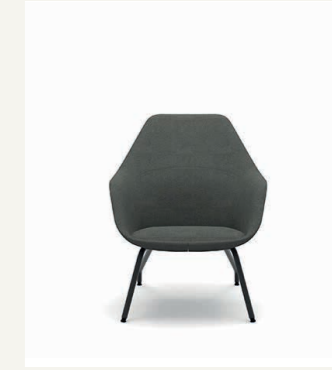

**Famiglia - FMG1105**  
Low back chair on 4 star base glides

Dimensions:

Seat Height	465mm
Seat Width	450mm
Seat Depth	450mm
Overall Height	810mm
Overall Width	640mm
Overall Depth	595mm

- Standard Features:
- Moulded foam construction
  - Fully Upholstered
  - 4 star Aluminium swivel base on glides finished in New Black powder coat
  - Plastic Glides

- Optional Features:
- Aluminium base available in a selection of powder coat finishes
  - 4 star auto return base on glides
  - Plastic Glides with felt
  - Multi-Fabrics

Frame Finishes:

New Black	
White	
Soft Gold	
Soft Silver	
Dark Bronze	
Deep Mulberry	

For larger swatches go to pg.172-173

**Famiglia - FMG1106**  
Low back chair on a 5 star base with casters

Dimensions:

Seat Height	515mm
Seat Width	450mm
Seat Depth	450mm
Overall Height	860mm
Overall Width	650mm
Overall Depth	595mm

- Standard Features:
- Moulded foam construction
  - Fully Upholstered
  - 5 star Aluminium swivel base with height adjustment on 50mm hard wheel casters finished in New Black powder coat

- Optional Features:
- Aluminium base available in a selection of powder coat finishes
  - 50mm soft wheel casters
  - Multi-Fabrics

Frame Finishes:

New Black	
White	
Soft Gold	
Soft Silver	
Dark Bronze	
Deep Mulberry	

For larger swatches go to pg.172-173

**Famiglia - FMG1201**  
Mid back on a recliner frame

Dimensions:

Seat Height	390mm
Seat Width	485mm
Seat Depth	485mm
Overall Height	835mm
Overall Width	720mm
Overall Depth	665mm

- Standard Features:
- Moulded foam construction with dual density back foam
  - Fully Upholstered
  - Tubular Steel reclined frame finished in New Black powder coat
  - Plastic Glides

- Optional Features:
- Tubular Steel frame available in a selection of powder coat finishes
  - Plastic Glides with felt
  - Multi-Fabrics

Frame Finishes:

New Black	
White	
Soft Gold	
Soft Silver	
Dark Bronze	
Deep Mulberry	

For larger swatches go to pg.172-173





# Famiglia

Design by Pearson Lloyd

64

65



**Famiglia - FMG1202**  
Mid back chair on a 4 leg frame

Dimensions:  
 Seat Height 470mm  
 Seat Width 490mm  
 Seat Depth 470mm  
 Overall Height 980mm  
 Overall Width 665mm  
 Overall Depth 665mm

- Standard Features:**
- Moulded foam construction with dual density back foam
  - Fully Upholstered
  - Tubular Steel frame finished in New Black powder coat
  - Plastic Glides

- Optional Features:**
- Tubular Steel frame available in a selection of powder coat finishes
  - Plastic Glides with felt
  - Multi-Fabrics

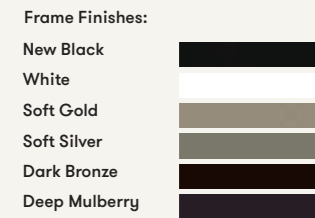

For larger swatches go to pg.172-173

**Famiglia - FMG1203**  
Mid back chair on wood legs

Dimensions:  
 Seat Height 375mm  
 Seat Width 470mm  
 Seat Depth 475mm  
 Overall Height 815mm  
 Overall Width 665mm  
 Overall Depth 730mm

- Standard Features:**
- Moulded foam construction with dual density back foam
  - Fully Upholstered
  - Solid Ash legs with a clear finish
  - Plastic Glides

- Optional Features:**
- Solid Ash legs can be stained or colour washed
  - Plastic Glides with felt
  - Multi-Fabrics

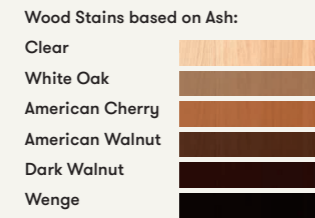

For larger swatches go to pg.177

16 optional Ash colour washes are also available please go to pg. 178 to see more.

**Famiglia - FMG1206**  
Mid back chair on a 5 star base with casters

Dimensions:  
 Seat Height 505mm  
 Seat Width 470mm  
 Seat Depth 490mm  
 Overall Height 1010mm  
 Overall Width 710mm  
 Overall Depth 680mm

- Standard Features:**
- Moulded foam construction with dual density back foam
  - Fully Upholstered
  - 5 star plastic base finished in Black
  - Dynamic free-floating recline and forward tilt with height adjustment
  - 65mm hard wheel casters

- Optional Features:**
- 5 star Aluminium swivel base in Polished Aluminium
  - 65mm soft wheel casters
  - Multi-Fabrics

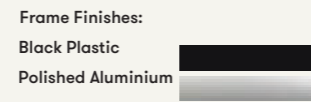

For larger swatches go to pg.1172-173



↓ Scan here to discover more



↓ Scan here to discover more



# Famiglia

Design by Pearson Lloyd



**Famiglia - FMG1401**  
Lounge Chair on wire frame

Dimensions:  
 Seat Height 415mm  
 Seat Width 545mm  
 Seat Depth 560mm  
 Overall Height 1090mm  
 Overall Width 880mm  
 Overall Depth 850mm

- Standard Features:**
- Moulded foam construction with dual density back foam
  - Fully Upholstered
  - Tubular Steel frame finished in New Black powder coat
  - Plastic glides

- Optional Features:**
- Tubular Steel frame available in a selection of powder coat finishes
  - Plastic Glides with felt
  - Multi-Fabrics

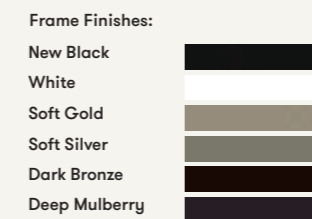

For larger swatches go to pg.172-173

**Famiglia - FMG1403**  
Lounge Chair on wooden frame

Dimensions:  
 Seat Height 410mm  
 Seat Width 545mm  
 Seat Depth 560mm  
 Overall Height 1080mm  
 Overall Width 880mm  
 Overall Depth 850mm

- Standard Features:**
- Moulded foam construction with dual density back foam
  - Fully Upholstered
  - Solid Ash legs with a clear finish
  - Plastic glides

- Optional Features:**
- Solid Ash legs can be stained or colour washed
  - Plastic Glides with felt
  - Multi-Fabrics



For larger swatches go to pg.177

16 optional Ash colour washes are also available please go to pg. 135 to see more.

**Famiglia - FMG1405**  
Lounge chair on a 4 star swivel base

Dimensions:  
 Seat Height 425mm  
 Seat Width 545mm  
 Seat Depth 560mm  
 Overall Height 1100mm  
 Overall Width 880mm  
 Overall Depth 910mm

- Standard Features:**
- Moulded foam construction with dual density back foam
  - Fully Upholstered
  - 4 Star Aluminium auto return swivel base in New Black powder coat
  - Plastic glides

- Optional Features:**
- 4 Star Aluminium auto return swivel available in a selection of powder coat finishes
  - 4 Star Aluminium auto return swivel available in Polished Aluminium
  - Multi-Fabrics

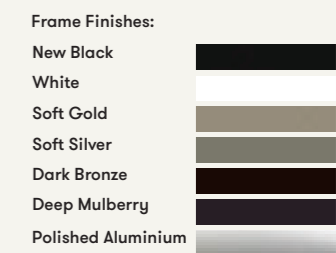

For larger swatches go to pg.172-173



# Famiglia

Design by Pearson Lloyd

66

67

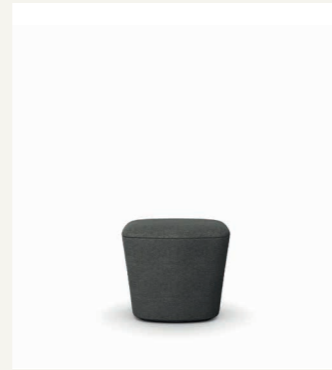

**Famiglia - FMG1501**  
High back on reclining frame

Dimensions:  
 Seat Height 400mm  
 Seat Width 495mm  
 Seat Depth 530mm  
 Overall Height 1175mm  
 Overall Width 1175mm  
 Overall Depth 830mm

Standard Features:  
 — Moulded foam construction with dual density back foam  
 — Fully Upholstered  
 — Tubular Steel reclined frame finished in New Black powder coat  
 — Plastic Glides

Optional Features:  
 — Tubular Steel frame available in a selection of powder coat finishes  
 — Plastic glides with felt  
 — Multi-Fabrics

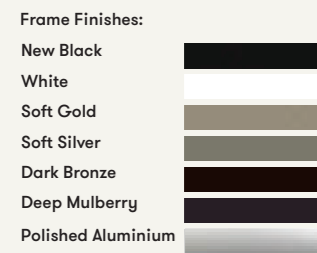

For larger swatches go to pg.172-173

**Famiglia - FMG1505**  
High back on 4 star swivel base

Dimensions:  
 Seat Height 410mm  
 Seat Width 495mm  
 Seat Depth 530mm  
 Overall Height 1195mm  
 Overall Width 865mm  
 Overall Depth 895mm

Standard Features:  
 — Moulded foam construction with dual density back foam  
 — Fully Upholstered  
 — 4 star Aluminium auto return swivel base finished in New Black powder coat  
 — Plastic Glides

Optional Features:  
 — 4 star Aluminium auto return swivel base available in a selection of powder coat finishes  
 — 4 star Aluminium auto return swivel base available in Polished Aluminium  
 — Multi-Fabrics

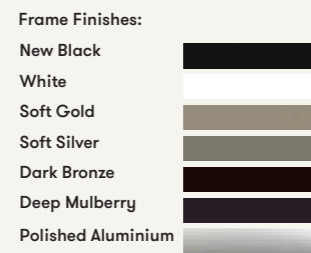

For larger swatches go to pg.172-173

**Famiglia - FMGFS**  
Footstool

Dimensions:  
 Seat Height 430mm  
 Seat Width 510mm  
 Seat Depth 440mm  
 Overall Height 430mm  
 Overall Width 510mm  
 Overall Depth 440mm

Standard Features:  
 — Moulded foam construction  
 — Fully Upholstered

Optional Features:  
 — Multi-Fabrics



↓ Scan here to discover more



↓ Scan here to discover more



# Fifty Series

Design by Allermuir Design Studio

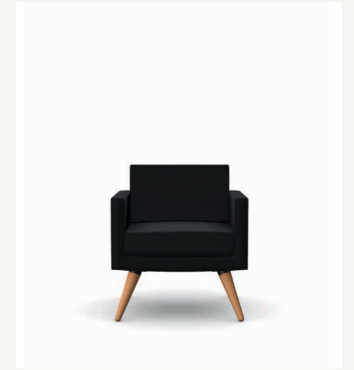
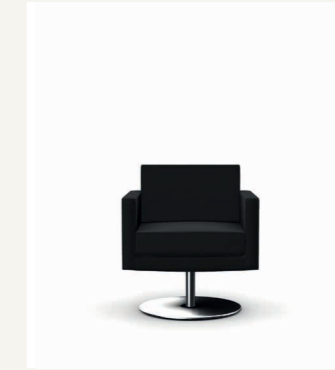
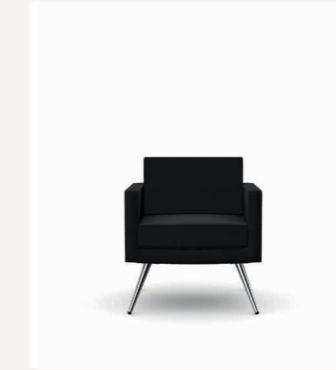

**Fifty Series - FIFT01**  
Armchair on swaged legs

Dimensions:  
 Seat Height 470mm  
 Seat Width 550mm  
 Seat Depth 460mm  
 Overall Height 770mm  
 Overall Width 700mm  
 Overall Depth 700mm

Standard Features:  
 — Traditional carcass construction  
 — Webbed seat support  
 — Fully upholstered  
 — Swaged Tubular Steel legs finished in Polished Chrome  
 — Plastic glides

Optional Features:  
 — Multi-Fabrics

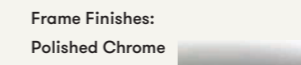

For larger swatches go to pg. 172-173

**Fifty Series - FIFT04**  
Armchair on a swivel pedestal base

Dimensions:  
 Seat Height 470mm  
 Seat Width 550mm  
 Seat Depth 460mm  
 Overall Height 770mm  
 Overall Width 700mm  
 Overall Depth 700mm

Standard Features:  
 — Traditional carcass construction  
 — Webbed seat support  
 — Fully upholstered  
 — Steel swivel pedestal base finished in Polished Chrome  
 — Plastic glides

Optional Features:  
 — Multi-Fabrics

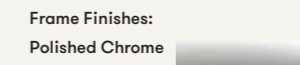

For larger swatches go to pg.172-173

**Fifty Series - FIFT05**  
Armchair on conical legs

Dimensions:  
 Seat Height 470mm  
 Seat Width 550mm  
 Seat Depth 460mm  
 Overall Height 770mm  
 Overall Width 700mm  
 Overall Depth 700mm

Standard Features:  
 — Traditional carcass construction  
 — Webbed seat support  
 — Fully upholstered  
 — Solid Beech conical legs with a clear finish  
 — Plastic glides

Optional Features:  
 — Solid beech conical legs can be stained or colour washed  
 — Multi-Fabrics

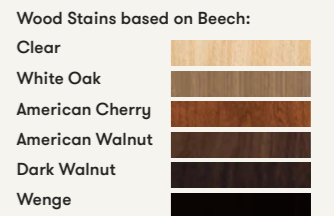

For larger swatches go to pg.177

16 optional Beech colour washes are also available please go to pg. 178 to see more.

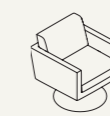

# Fifty Series

Design by Allermuir Design Studio

68

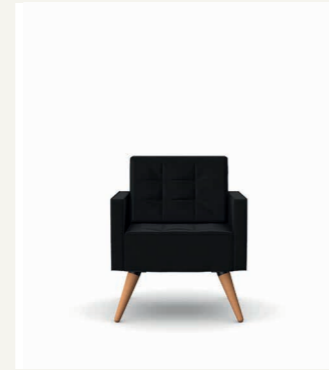
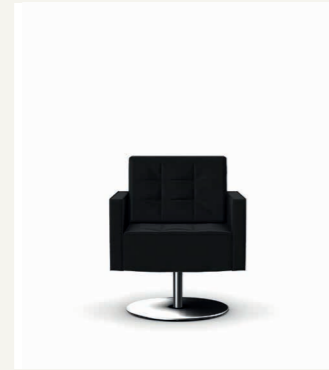
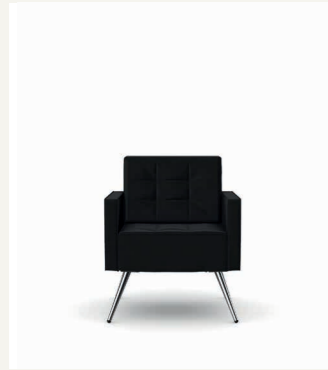

**Fifty Series - FIFT11**  
Arm chair - High back, tufted seat and back upholstery, metal leg

**Dimensions:**

Seat Height	470mm
Seat Width	550mm
Seat Depth	460mm
Overall Height	800mm
Overall Width	700mm
Overall Depth	700mm

**Standard Features:**

- Traditional carcass construction
- Webbed seat support
- Fully upholstered
- Tufted seat and back upholstery
- High back
- Swaged Tubular Steel legs finished in Polished Chrome
- Plastic glides

**Optional Features:**

- Multi-Fabrics

**Frame Finishes:**

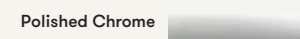

For larger swatches go to pg.172-173

**Fifty Series - FIFT14**  
Arm chair - High back, tufted seat and back upholstery, pedestal base

**Dimensions:**

Seat Height	470mm
Seat Width	550mm
Seat Depth	460mm
Overall Height	800mm
Overall Width	700mm
Overall Depth	700mm

**Standard Features:**

- Traditional carcass construction
- Webbed seat support
- Fully upholstered
- Tufted seat and back upholstery
- High back
- Steel swivel pedestal based finished in polished chrome
- Plastic glides

**Optional Features:**

- Multi-Fabrics

**Frame Finishes:**

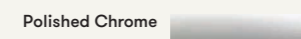

For larger swatches go to pg.172-173

**Fifty Series - FIFT15**  
Arm chair - High back, tufted seat and back upholstery, wood legs

**Dimensions:**

Seat Height	470mm
Seat Width	550mm
Seat Depth	460mm
Overall Height	800mm
Overall Width	700mm
Overall Depth	700mm

**Standard Features:**

- Traditional carcass construction
- Webbed seat support
- Fully upholstered
- Tufted seat and back upholstery
- High back
- Solid Beech conical legs with a clear finish
- Plastic glides

**Optional Features:**

- Solid Beech conical legs can be stained or colour washed
- Multi-Fabrics

**Wood Stains based on Beech:**



For larger swatches go to pg.177

16 optional Beech colour washes are also available please go to pg. 178 to see more.

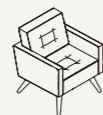
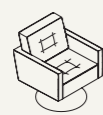

↓ Scan here to discover more



↓ Scan here to discover more



# Fifty Series

Design by Allermuir Design Studio

69

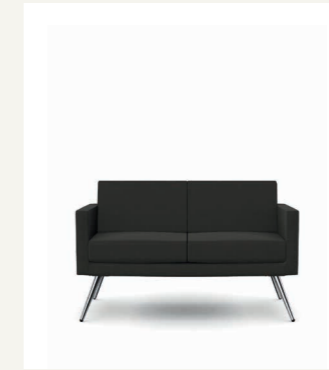

**Fifty Series - FIFT02**  
Two seat sofa on swaged legs

**Dimensions:**

Seat Height	470mm
Seat Width	1100mm
Seat Depth	460mm
Overall Height	770mm
Overall Width	1280mm
Overall Depth	700mm

**Standard Features:**

- Traditional carcass construction
- Webbed seat support
- Fully upholstered
- Swaged Tubular Steel legs finished in Polished Chrome
- Plastic glides

**Optional Features:**

- Multi-Fabrics

**Frame Finishes:**

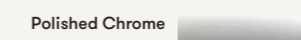

For larger swatches go to pg.172-173

**Fifty Series - FIFT06**  
Two seat sofa on conical legs

**Dimensions:**

Seat Height	470mm
Seat Width	1100mm
Seat Depth	460mm
Overall Height	770mm
Overall Width	1280mm
Overall Depth	700mm

**Standard Features:**

- Traditional carcass construction
- Webbed seat support
- Fully upholstered
- Solid Beech conical legs with a clear finish
- Plastic glides

**Optional Features:**

- Solid Beech conical legs can be stained or colour washed
- Multi-Fabrics

**Wood Stains based on Beech:**

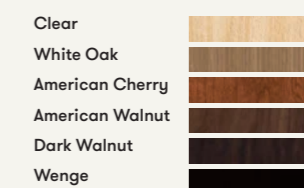

For larger swatches go to pg.177

16 optional Beech colour washes are also available please go to pg. 178 to see more.



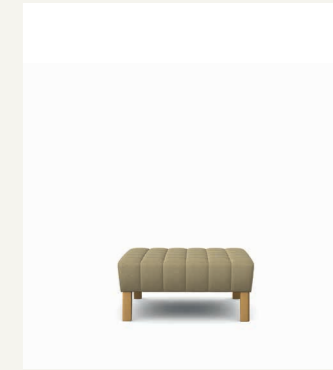
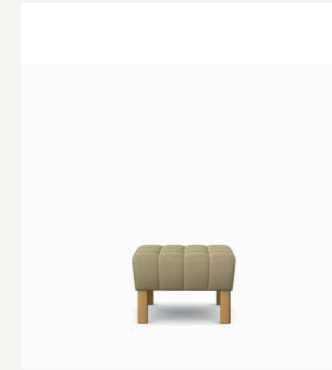
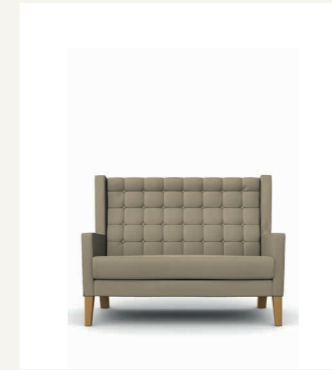
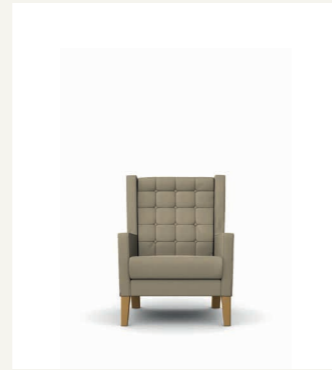
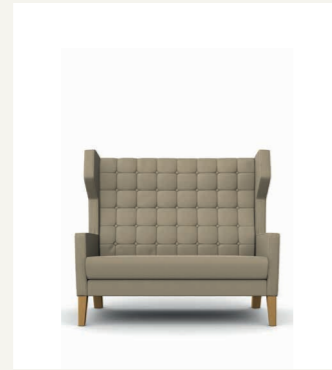
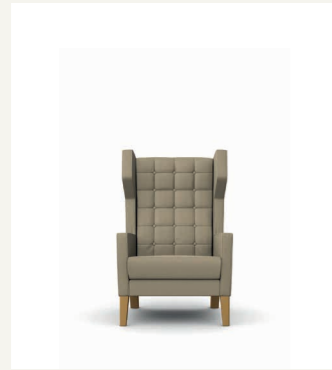

**Grainger - GR1**  
High backed winged armchair

Dimensions:  
 Seat Height 470mm  
 Seat Width 580mm  
 Seat Depth 510mm  
 Overall Height 1170mm  
 Overall Width 755mm  
 Overall Depth 875mm

- Standard Features:
- Traditional carcass construction
  - Secured deep buttoned back cushion
  - Webbed seat support
  - Solid Oak legs with a clear finish

- Optional Features:
- Solid Oak legs can be stained or colour washed
  - Multi-Fabrics

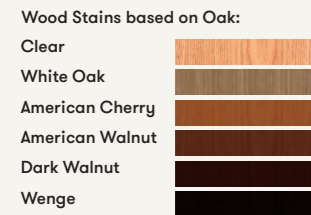

For larger swatches go to pg.177

16 optional Oak colour washes are also available please go to pg. 178 to see more.

**Grainger - GR2**  
High backed winged two seat sofa

Dimensions:  
 Seat Height 470mm  
 Seat Width 1160mm  
 Seat Depth 510mm  
 Overall Height 1170mm  
 Overall Width 1350mm  
 Overall Depth 875mm

- Standard Features:
- Traditional carcass construction
  - Secured deep buttoned back cushion
  - Webbed seat support
  - Solid Oak legs with a clear finish

- Optional Features:
- Solid Oak legs can be stained or colour washed
  - Multi-Fabrics

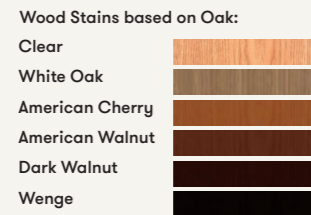

For larger swatches go to pg.177

16 optional Oak colour washes are also available please go to pg. 178 to see more.

**Grainger - GR3**  
Low backed armchair

Dimensions:  
 Seat Height 470mm  
 Seat Width 580mm  
 Seat Depth 510mm  
 Overall Height 1020mm  
 Overall Width 755mm  
 Overall Depth 850mm

- Standard Features:
- Traditional carcass construction
  - Secured deep buttoned back cushion
  - Webbed seat support
  - Solid Oak legs with a clear finish

- Optional Features:
- Solid Oak legs can be stained or colour washed
  - Multi-Fabrics

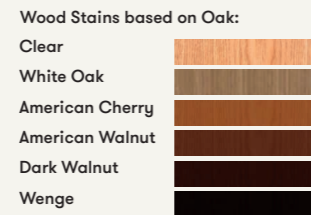

For larger swatches go to pg.177

16 optional Oak colour washes are also available please go to pg. 178 to see more.

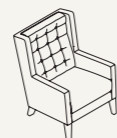
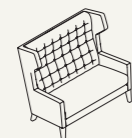

↓ Scan here to discover more



↓ Scan here to discover more



**Grainger - GR4**  
Low backed two seat sofa

Dimensions:  
 Seat Height 470mm  
 Seat Width 1160mm  
 Seat Depth 510mm  
 Overall Height 1020mm  
 Overall Width 1350mm  
 Overall Depth 850mm

- Standard Features:
- Traditional carcass construction
  - Secured deep buttoned back cushion
  - Webbed seat support
  - Solid Oak legs with a clear finish

- Optional Features:
- Solid Oak legs can be stained or colour washed
  - Multi-Fabrics

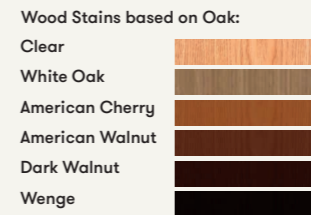

For larger swatches go to pg.177

16 optional Oak colour washes are also available please go to pg. 178 to see more.

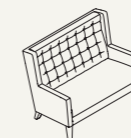

**Grainger - GR7**  
Small ottoman

Dimensions:  
 Overall Height 388mm  
 Overall Width 610mm  
 Overall Depth 610mm

- Standard Features:
- Traditional carcass construction
  - Webbed seat support
  - Solid Oak legs with a clear finish

- Optional Features:
- Solid Oak legs can be stained or colour washed
  - Multi-Fabrics

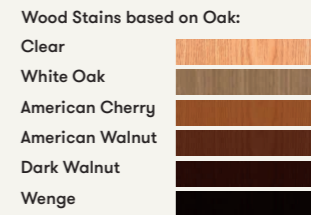

For larger swatches go to pg.177

16 optional Oak colour washes are also available please go to pg. 178 to see more.



**Grainger - GR8**  
Large ottoman

Dimensions:  
 Overall Height 388mm  
 Overall Width 910mm  
 Overall Depth 910mm

- Standard Features:
- Traditional carcass construction
  - Webbed seat support
  - Solid Oak legs with a clear finish

- Optional Features:
- Solid Oak legs can be stained or colour washed
  - Multi-Fabrics

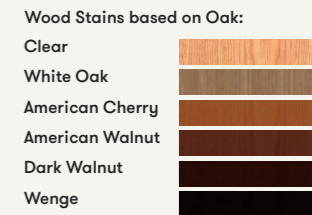

For larger swatches go to pg.177

16 optional Oak colour washes are also available please go to pg. 178 to see more.

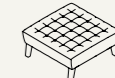

# Haven

Design by Mark Gabbertas

72

73



## Haven

### Standard Features:

- Moulded foam construction
- Webbed seat support
- Fully upholstered
- Aluminium frame finished in Black (Textured) powder coat
- Plastic glides

### Optional Features:

- Under frame power unit (2x powered USB/TUF and 1x power socket)
- Multi-Fabrics
- HALD, seat linking device available on select models only

### Frame Finishes:

Black (Textured)

For larger swatches go to pg.124-126



HA102  
OH: 795mm  
OW: 1135mm  
OD: 810mm



HA202  
OH: 795mm  
OW: 2000mm  
OD: 810mm



HAM100  
OH: 795mm  
OW: 765mm  
OD: 810mm



HAM101RH  
OH: 795mm  
OW: 1000mm  
OD: 810mm



HAM101LH  
OH: 795mm  
OW: 1000mm  
OD: 810mm



HA102HR  
OH: 1190mm  
OW: 1135mm  
OD: 810mm



HAM200  
OH: 795mm  
OW: 1530mm  
OD: 810mm



HAM201RH  
OH: 795mm  
OW: 1825mm  
OD: 810mm



HAM201RH  
OH: 795mm  
OW: 1825mm  
OD: 810mm



HAM100HR  
OH: 1190mm  
OW: 765mm  
OD: 810mm



HAM101HRLH  
OH: 1190mm  
OW: 1000mm  
OD: 810mm



HAM101HRRH  
OH: 1190mm  
OW: 1000mm  
OD: 810mm



HAM200HR  
OH: 1190mm  
OW: 1135mm  
OD: 810mm



HAM201HRRH  
OH: 1190mm  
OW: 1825mm  
OD: 810mm



HAM201HRLH  
OH: 1190mm  
OW: 1825mm  
OD: 810mm



HA202HR  
OH: 1190mm  
OW: 2000mm  
OD: 810mm



HAO104  
OH: 430mm  
OW: 780mm  
OD: 580mm

## Configurations:

Create your own using our product configurator at [allermuir.com](http://allermuir.com)

1. HAM101RH  
HAM100  
HAM101LH

1

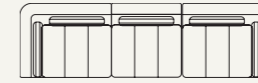

2

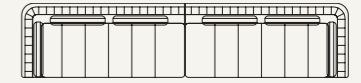

2. HAM201HRRH  
HAM201HRLH

3. HAM201HRRH  
HAM101HRLH  
HAM201HRLH

3

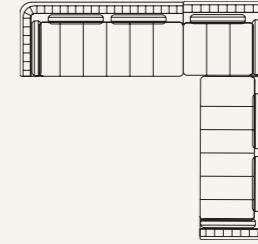

4

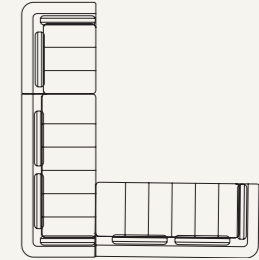

4. HAM201RH x 2  
HAM101LH

5. HAM201RH x 2  
HAM100  
HAM201LH x 2

5

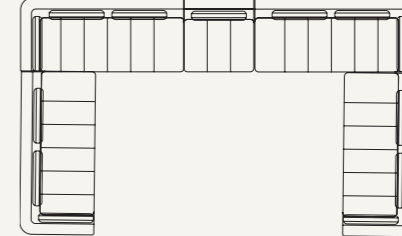

6

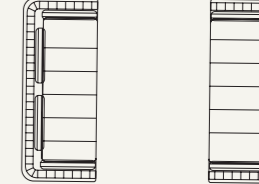

6. HA200HR  
HA200HR

7. HAM201HRRH x 2  
HAM100HR x 2  
HAM201HRLH

7

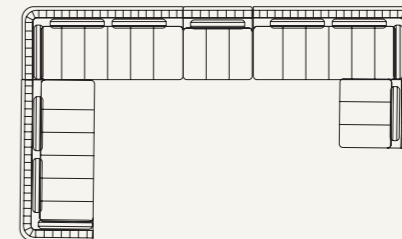

↓ Scan here to discover more



# Haven Bench

Design By Mark Gabbertas

74

75



## Haven Bench

### Standard Features:

- Traditional carcass construction
- Fully upholstered bench with quilted detail
- Fully upholstered
- Plastic glides
- Steel frame finished in Black (Textured) powder coat
- Black casters
- Available in 3 sizes - 1200mm, 1500mm and 1800mm

### Optional Features:

- Plastic glides with felt
- Bench to bench linking options available on select models

### Frame Finishes:

Black (Textured) 

For larger swatches go to pg.172-173

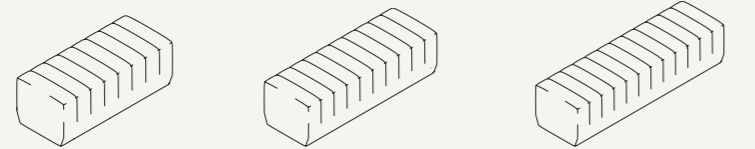

**HAB100** - 1200mm bench  
no linking connectors  
OH: 450mm  
OW: 1200mm  
OD: 550mm

**HAB200** - 1500mm bench  
no linking connectors  
OH: 450mm  
OW: 1500mm  
OD: 550mm

**HAB300** - 1800mm bench  
no linking connectors  
OH: 450mm  
OW: 1800mm  
OD: 550mm

**HAB100M**  
1200mm bench linking  
connectors both ends  
**HAB100E**  
1200mm bench linking  
connectors one end

**HAB200M**  
1500mm bench linking  
connectors both ends  
**HAB200E**  
1500mm bench linking  
connectors one end

**HAB300M**  
1800mm bench linking  
connectors both ends  
**HAB300E**  
1800mm bench linking  
connectors one end

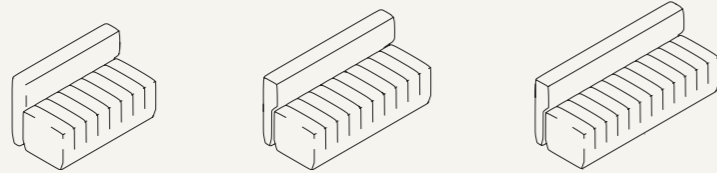

**HAB100B** - 1200mm bench with  
bulwark, no linking connectors  
OH: 780mm  
OW: 1200mm  
OD: 695mm

**HAB200B** - 1500mm bench with  
bulwark, no linking connectors  
OH: 780mm  
OW: 1500mm  
OD: 695mm

**HAB300B** - 1800mm bench with  
bulwark, no linking connectors  
OH: 780mm  
OW: 1800mm  
OD: 695mm

**HAB100BM**  
1200mm bench linking  
connectors both ends

**HAB200BM**  
1500mm bench linking  
connectors both ends

**HAB300BM**  
1800mm bench linking  
connectors both ends

**HAB100BELH / HAB100BERH**  
1200mm bench left / right  
hand linking connectors

**HAB200BELH / HAB200BERH**  
1500mm bench left / right  
hand linking connectors

**HAB300BELH / HAB300BERH**  
1800mm bench left / right  
hand linking connectors

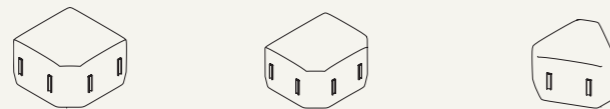

**HAB2WC90**  
OH: 450mm  
OW: 890mm  
OD: 820mm

**HAB3WC90**  
OH: 450mm  
OW: 760mm  
OD: 660mm

**HAB3WC60**  
OH: 450mm  
OW: 555mm  
OD: 525mm



**HAB2WC45**  
OH: 450mm  
OW: 680mm  
OD: 610mm

**HAS040LC**  
OH: 480mm  
OW: 400mm  
OD: 400mm

**HAS040L**  
OH: 480mm  
OW: 400mm  
OD: 400mm

## Configurations:

Create your own using our product configurator at [allermuir.com](http://allermuir.com)

1. **HAB200BELH**  
**HAB200BM**  
**HAB200BERH**

1



2



2. **HAB100E**  
**HAB300E**  
**HAB2WC90**

3. **HAB3WC90**  
**HAB200BELH**  
**HAB200BM**  
**HAB200BERH**  
**HAB300E**

3



4



4. **HAB300BM x 3**  
**HAB2WC90 x 2**

5. **HAB300E x 2**  
**HAB300M**  
**HAB2WC90**

5

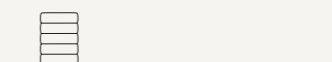

6



6. **HAB300E x 3**  
**HA200HR**

7. **HAB100BM x 2**  
**HAB200BELH**  
**HAB200BERH**  
**HAB2WC45 x 2**

7



8



8. **HAB100E**  
**HAB2WC90**  
**HAB300BM**  
**HAB2WC45**  
**HAB200BERH**

9. **HAB200BELH**  
**HAB2WC45**  
**HAB300BM x 2**  
**HAB2WC90**  
**HAB200E**

9

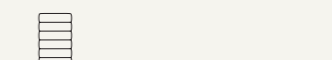

↓ Scan here to  
discover more



# Jinx

Design by Allermuir Design Studio

76

77

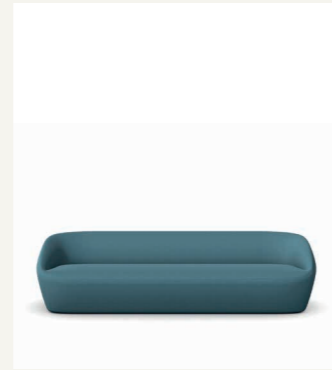
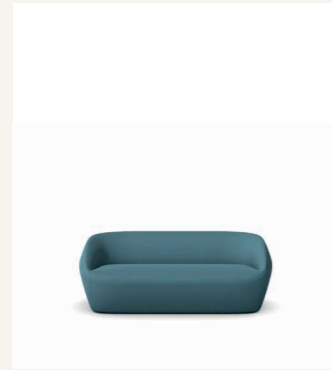
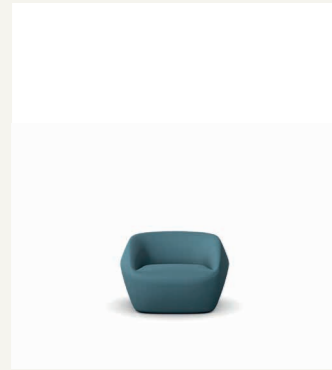

**Jinx - JNX01**  
Lounge chair

**Dimensions:**

Seat Height	410mm
Seat Width	550mm
Seat Depth	570mm
Overall Height	665mm
Overall Width	1005mm
Overall Depth	965mm

**Standard Features:**

- Wood carcass construction
- Dual density back foam
- Sprung seat foam
- Fully upholstered
- Plastic glides

**Optional Features:**

- Solid ash side shelf with a clear finish
- Ash side shelf can be stained or colour washed
- Swivel base
- Plastic glides with felt
- Two-tone upholstery

**Wood Stains based on Ash:**

Clear	
White Oak	
American Cherry	
American Walnut	
Dark Walnut	
Wenge	

For larger swatches go to pg.172-173

16 optional Ash colour washes are also available please go to pg. 178 to see more.

**Jinx - JNX02**  
2 seat sofa

**Dimensions:**

Seat Height	410mm
Seat Width	1425mm
Seat Depth	570mm
Overall Height	665mm
Overall Width	1850mm
Overall Depth	965mm

**Standard Features:**

- Wood carcass construction
- Dual density back foam
- Sprung seat foam
- Fully upholstered
- Plastic glides

**Optional Features:**

- Plastic glides available with felt
- Two-tone upholstery

**Jinx - JNX03**  
3 seat sofa

**Dimensions:**

Seat Height	410mm
Seat Width	2135mm
Seat Depth	570mm
Overall Height	665mm
Overall Width	2540mm
Overall Depth	965mm

**Standard Features:**

- Wood carcass construction
- Dual density back foam
- Sprung seat foam
- Fully upholstered
- Plastic glides

**Optional Features:**

- Plastic glides available with felt
- Two-tone upholstery



↓ Scan here to discover more



↓ Scan here to discover more



# Lola

Design by Wolfgang C. R. Mezger

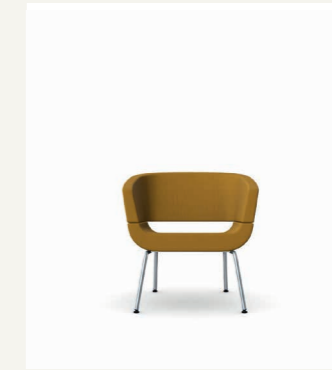
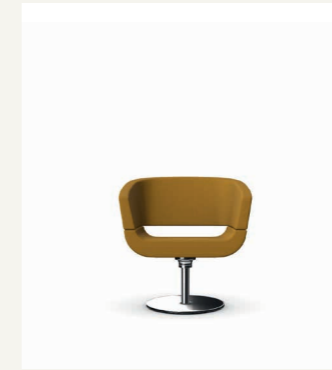

**Lola - A820**  
Lounge chair on swivel pedestal base

**Dimensions:**

Seat Height	440mm
Seat Width	560mm
Seat Depth	490mm
Overall Height	745mm
Overall Width	770mm
Overall Depth	670mm

**Standard Features:**

- Moulded foam construction
- Fully upholstered
- Steel swivel pedestal base finished in Polished Chrome
- Plastic glides

**Optional Features:**

- Multi-Fabrics

**Frame Finishes:**

Polished Chrome	
-----------------	--

For larger swatches go to pg.172-173

**Lola - A821**  
Lounge chair on 4 leg frame

**Dimensions:**

Seat Height	440mm
Seat Width	560mm
Seat Depth	490mm
Overall Height	745mm
Overall Width	770mm
Overall Depth	670mm

**Standard Features:**

- Moulded foam construction
- Fully upholstered
- Tubular steel frame finished in Polished Chrome powder coat
- Plastic self-levelling glides

**Optional Features:**

- Tubular steel frame available in Polished Chrome
- Plastic self-levelling glides with felt
- Multi-Fabrics

**Frame Finishes:**

Polished Chrome	
-----------------	--

For larger swatches go to pg.172-173

**Lola - A825**  
Lounge chair on 4 leg wooden frame

**Dimensions:**

Seat Height	440mm
Seat Width	560mm
Seat Depth	490mm
Overall Height	745mm
Overall Width	770mm
Overall Depth	670mm

**Standard Features:**

- Moulded foam construction
- Fully upholstered
- Solid Beech legs with a clear finish

**Optional Features:**

- Solid Beech legs can be stained or colour washed
- Solid Oak legs with a clear finish
- Multi-Fabrics

**Solid Wood Finishes:**

Clear on Beech	
Clear on Oak	

**Wood Stains based on Beech:**

Clear	
White Oak	
American Cherry	
American Walnut	
Dark Walnut	
Wenge	

For larger swatches go to pg.176-177

16 optional Beech colour washes are also available please go to pg. 178 to see more.



# Lola

Design by Wolfgang C. R. Mezger

78

79

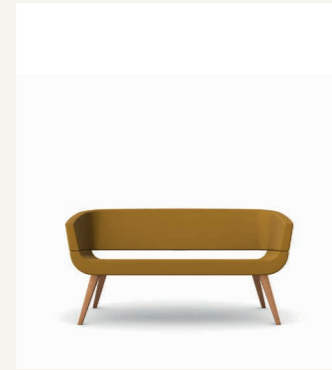
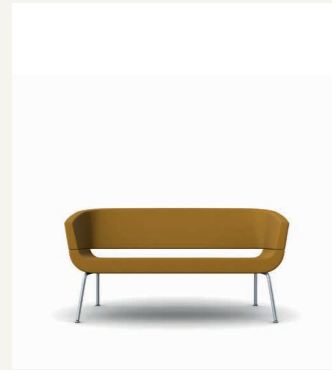

## Lola - A822 Sofa on a 4 leg frame

### Dimensions:

Seat Height	440mm
Seat Width	1320mm
Seat Depth	490mm
Overall Height	745mm
Overall Width	1525mm
Overall Depth	670mm

### Standard Features:

- Moulded foam construction
- Fully upholstered
- Tubular steel frame finished in Polished Chrome powder coat
- Plastic self-levelling glides

### Optional Features:

- Plastic self-levelling glides with felt
- Multi-Fabrics

### Frame Finishes:

Polished Chrome 

For larger swatches go to pg.172-173

## Lola - A826 Sofa on 4 leg wooden frame

### Dimensions:

Seat Height	440mm
Seat Width	1320mm
Seat Depth	490mm
Overall Height	745mm
Overall Width	1525mm
Overall Depth	670mm

### Standard Features:

- Moulded foam construction
- Fully upholstered
- Solid Beech legs with a clear finish

### Optional Features:

- Solid Beech legs can be stained or colour washed
- Solid Oak legs with a clear finish
- Multi-Fabrics

### Solid Wood Finishes:

Clear on Beech   
Clear on Oak 

### Wood Stains based on Beech:

Clear   
White Oak   
American Cherry   
American Walnut   
Dark Walnut   
Wenge 

For larger swatches go to pg.177-178

16 optional Beech colour washes are also available please go to pg. 178 to see more.



# Mayze Moblie

Design by Allermuir Design Studio

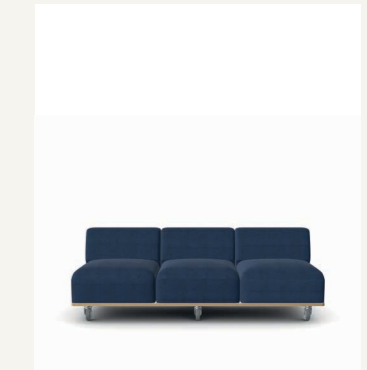
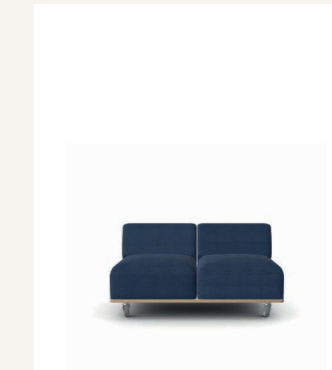
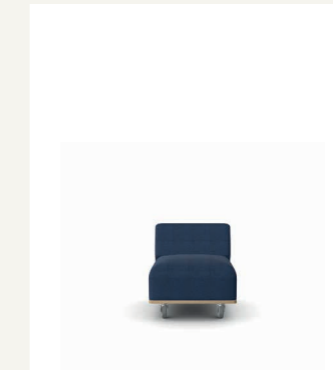

## Mayze Mobile - MZE100C Single Seat

### Dimensions:

Seat Height	390mm
Seat Width	675mm
Seat Depth	675mm
Overall Height	705mm
Overall Width	675mm
Overall Depth	875mm

### Standard Features:

- Traditional carcass construction
- Tensioned seat support
- 25mm Plywood base with a clear edge finish
- Heavy duty casters with wheel break

### Optional Features:

- Multi-fabrics

## Mayze Mobile - MZE200C Two Seat

### Dimensions:

Seat Height	390mm
Seat Width	1350mm
Seat Depth	675mm
Overall Height	705mm
Overall Width	1350mm
Overall Depth	875mm

### Standard Features:

- Traditional carcass construction
- Tensioned seat support
- 25mm Plywood base with a clear edge finish
- Heavy duty casters with wheel break

### Optional Features:

- Multi-fabrics

## Mayze Mobile - MZE300C Three Seat

### Dimensions:

Seat Height	390mm
Seat Width	2025mm
Seat Depth	675mm
Overall Height	705mm
Overall Width	2025mm
Overall Depth	875mm

### Standard Features:

- Traditional carcass construction
- Tensioned seat support
- 25mm Plywood base with a clear edge finish
- Heavy duty casters with wheel break

### Optional Features:

- Multi-fabrics

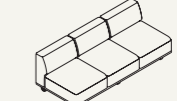
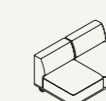
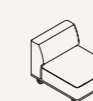

↓ Scan here to discover more



↓ Scan here to discover more





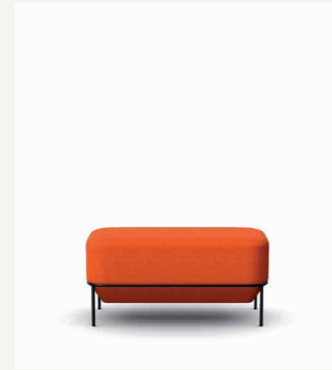
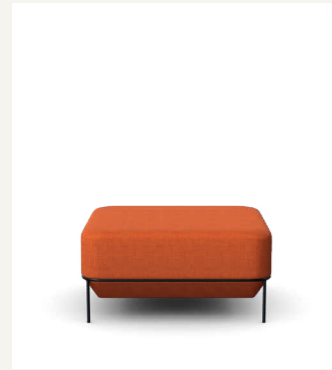
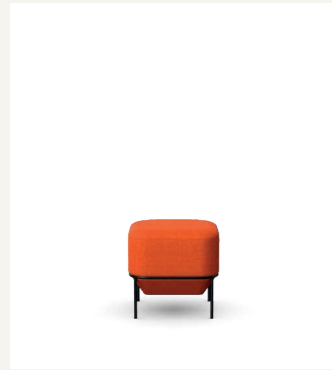

### Mozaik - MZK101 Low square stool, small

Dimensions:  
Overall Height 420mm  
Overall Width 435mm  
Overall Depth 435mm

- Standard Features:
- Traditional carcass construction
  - Fully upholstered
  - Wire frame finished in Black powder coat
  - Plastic glides

- Optional Features:
- Wire frame available in a White powder coat finish
  - Two-tone upholstery

#### Frame Finishes:

Black 

White 

For larger swatches go to pg.172-173

### Mozaik - MZK102 Large low square stool

Dimensions:  
Overall Height 420mm  
Overall Width 865mm  
Overall Depth 865mm

- Standard Features:
- Traditional carcass construction
  - Fully upholstered
  - Wire frame finished in Black powder coat
  - Plastic glides

- Optional Features:
- Wire frame available in a White powder coat finish
  - Two-tone upholstery

#### Frame Finishes:

Black 

White 

For larger swatches go to pg.172-173

### Mozaik - MZK103 Low rectangular bench

Dimensions:  
Overall Height 420mm  
Overall Width 435mm  
Overall Depth 865mm

- Standard Features:
- Traditional carcass construction
  - Fully upholstered
  - Wire frame finished in Black powder coat
  - Plastic glides

- Optional Features:
- Wire frame available in a White powder coat finish
  - Two-tone upholstery

#### Frame Finishes:

Black 

White 

For larger swatches go to pg.172-173

### Mozaik - MZK201 Small high square stool

Dimensions:  
Overall Height 595mm  
Overall Width 435mm  
Overall Depth 435mm

- Standard Features:
- Traditional carcass construction
  - Fully upholstered
  - Wire frame finished in Black powder coat
  - Plastic glides

- Optional Features:
- Wire frame available in a White powder coat finish
  - Two-tone upholstery

#### Frame Finishes:

Black 

White 

For larger swatches go to pg.172-173

### Mozaik - MZK203 High rectangular bench

Dimensions:  
Overall Height 595mm  
Overall Width 435mm  
Overall Depth 865mm

- Standard Features:
- Traditional carcass construction
  - Fully upholstered
  - Wire frame finished in Black powder coat
  - Plastic glides

- Optional Features:
- Wire frame available in a White powder coat finish
  - Two-tone upholstery

#### Frame Finishes:

Black 

White 

For larger swatches go to pg.172-173



↓ Scan here to discover more



↓ Scan here to discover more



# Open

Design By Pearson Lloyd

82

83

# Open

Design By Pearson Lloyd

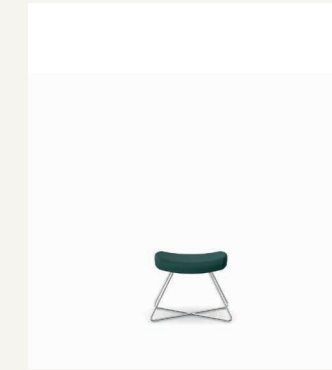
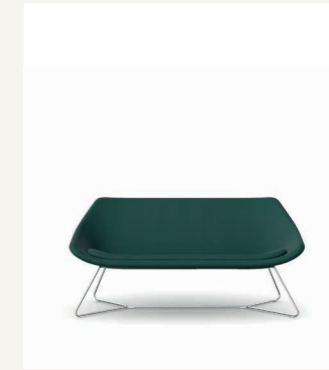
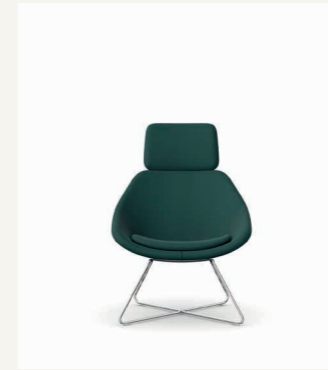
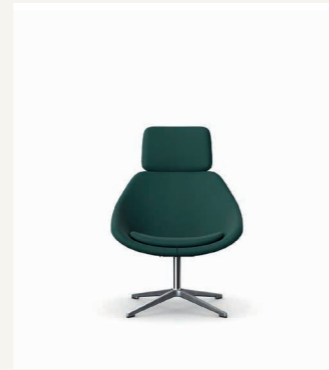
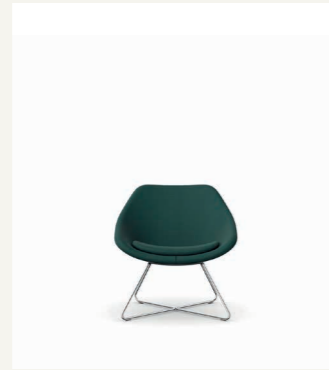
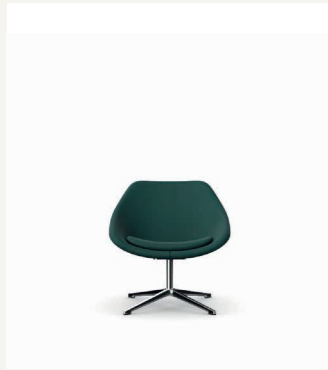

## Open - OPN104 Lounge chair on a 4 star swivel base

### Dimensions:

Seat Height	460mm
Seat Width	460mm
Seat Depth	500mm
Overall Height	770mm
Overall Width	780mm
Overall Depth	860mm

### Standard Features:

- Moulded foam construction with dual density back foam
- Fully upholstered
- 4 star Aluminium auto return swivel base finished in New Black powder coat
- Plastic glides

### Optional Features:

- 4 star auto return swivel base available in Polished Aluminium and a selection of powder coat finishes
- Multi-Fabrics

### Frame Finishes:

New Black	
White	
Soft Gold	
Soft Silver	
Dark Bronze	
Deep Mulberry	
Polished Aluminium	

For larger swatches go to pg.172-173

## Open - OPN108 Lounge chair on a wire frame

### Dimensions:

Seat Height	460mm
Seat Width	460mm
Seat Depth	500mm
Overall Height	770mm
Overall Width	745mm
Overall Depth	800mm

### Standard Features:

- Moulded foam construction with dual density back foam
- Fully upholstered
- Wire frame finished in Polished Chrome
- Plastic glides

### Optional Features:

- Wire frame available in a selection of powder coat finishes
- Multi-Fabrics

### Frame Finishes:

New Black	
White	
Soft Gold	
Soft Silver	
Dark Bronze	
Deep Mulberry	
Polished Aluminium	

For larger swatches go to pg.172-173

## Open - OPN154 Lounge chair with headrest on a 4 star swivel base

### Dimensions:

Seat Height	460mm
Seat Width	460mm
Seat Depth	500mm
Overall Height	1050mm
Overall Width	780mm
Overall Depth	860mm

### Standard Features:

- Moulded foam construction with dual density back foam
- Fully upholstered
- 4 star Aluminium auto return swivel base finished in New Black powder coat
- Plastic glides

### Optional Features:

- 4 star auto return swivel base available in Polished Aluminium and a selection of powder coat finishes
- Multi-Fabrics

### Frame Finishes:

New Black	
White	
Soft Gold	
Soft Silver	
Dark Bronze	
Deep Mulberry	
Polished Aluminium	

For larger swatches go to pg.172-173

## Open - OPN158 Lounge chair with headrest on a wire frame

### Dimensions:

Seat Height	460mm
Seat Width	460mm
Seat Depth	500mm
Overall Height	1050mm
Overall Width	745mm
Overall Depth	800mm

### Standard Features:

- Moulded foam construction with dual density back foam
- Fully upholstered
- Wire frame finished in Polished Chrome
- Plastic glides

### Optional Features:

- Wire frame available in a selection of powder coat finishes
- Multi-Fabrics

### Frame Finishes:

New Black	
White	
Soft Gold	
Soft Silver	
Dark Bronze	
Deep Mulberry	
Polished Aluminium	

For larger swatches go to pg.172-173

## Open - OPN208 Sofa on a wire frame

### Dimensions:

Seat Height	460mm
Seat Width	1300mm
Seat Depth	500mm
Overall Height	770mm
Overall Width	1600mm
Overall Depth	800mm

### Standard Features:

- Moulded foam construction with dual density back foam
- Fully upholstered
- Wire frame finished in Polished Chrome
- Plastic glides

### Optional Features:

- Wire frame available in a selection of powder coat finishes
- Multi-Fabrics

### Frame Finishes:

New Black	
White	
Soft Gold	
Soft Silver	
Dark Bronze	
Deep Mulberry	
Polished Aluminium	

For larger swatches go to pg.172-173

## Open - OPNFS8 Footstool on a wire frame

### Dimensions:

Seat Height	440mm
Seat Width	550mm
Seat Depth	510mm
Overall Height	440mm
Overall Width	550mm
Overall Depth	510mm

### Standard Features:

- Moulded foam construction
- Fully upholstered
- Wire frame finished in Polished Chrome
- Plastic glides

### Optional Features:

- Wire frame available in a selection of powder coat finishes

### Frame Finishes:

New Black	
White	
Soft Gold	
Soft Silver	
Dark Bronze	
Deep Mulberry	
Polished Aluminium	

For larger swatches go to pg.172-173

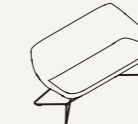

# Pause

Design by Allermuir Design Studio

84

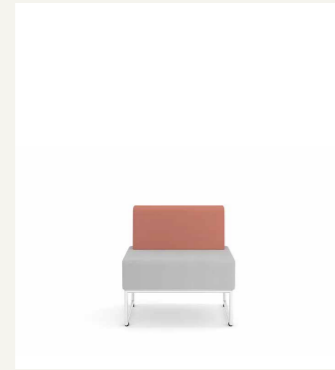
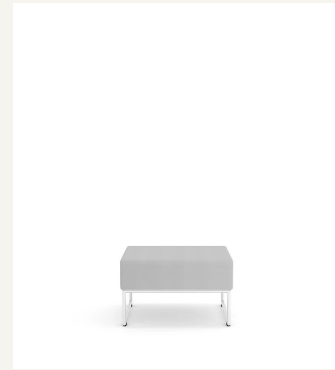

## Pause - PSM100 Single seat unit

### Standard Features:

- Traditional carcass construction
- Moulded foam back construction
- Tubular steel frame finished in Polished Chrome powder coat
- Plastic glides with levelling adjustment

### Optional Features:

- Seat to seat linking
- Multi-Fabrics

### Frame Finishes:

Polished Chrome 

For larger swatches go to pg.172-173

## Pause - PSM102 Single seat unit with a full back

### Standard Features:

- Traditional carcass construction
- Moulded foam back construction
- Tubular steel frame finished in Polished Chrome powder coat
- Plastic glides with levelling adjustment

### Optional Features:

- Seat to seat linking
- Multi-Fabrics

### Frame Finishes:

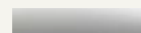
Polished Chrome 

For larger swatches go to pg.172-173

## Pause - PSM202 Two seat unit with two backrests

### Standard Features:

- Traditional carcass construction
- Moulded foam back construction
- Tubular steel frame finished in Polished Chrome powder coat
- Plastic glides with levelling adjustment

### Optional Features:

- Seat to seat linking
- Multi-Fabrics

### Frame Finishes:

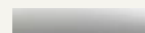

Polished Chrome 

For larger swatches go to pg.172-173

# Pause

Design by Allermuir Design Studio

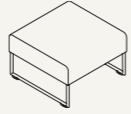
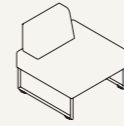
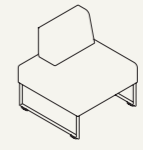
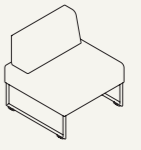
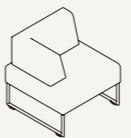
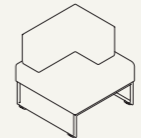
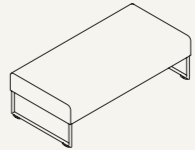
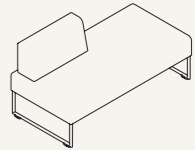
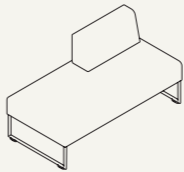
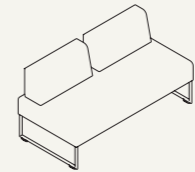
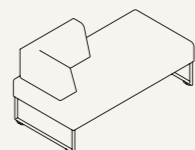
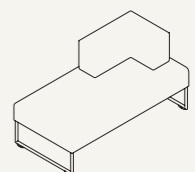
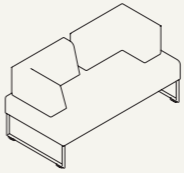
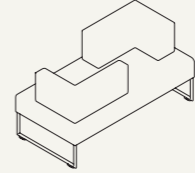
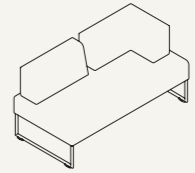
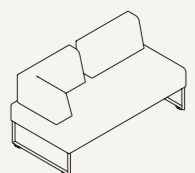
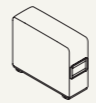
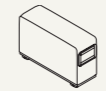
85

			
PSM100 OH: 450mm OW: 750mm OD: 750mm	PSM101RH OH: 780mm OW: 750mm OD: 750mm	PSM101LH OH: 780mm OW: 750mm OD: 750mm	PSM102 OH: 780mm OW: 750mm OD: 750mm
			
PSM103RH OH: 780mm OW: 750mm OD: 750mm	PSM103LH OH: 780mm OW: 750mm OD: 750mm	PSM200 OH: 450mm OW: 1500mm OD: 750mm	PSM201RH OH: 780mm OW: 1500mm OD: 750mm
			
PSM201LH OH: 780mm OW: 1500mm OD: 750mm	PSM202 OH: 780mm OW: 1500mm OD: 750mm	PSM203RH OH: 780mm OW: 1500mm OD: 750mm	PSM203LH OH: 780mm OW: 1500mm OD: 750mm
			
PSM204 OH: 780mm OW: 1500mm OD: 750mm	PSM205 OH: 780mm OW: 1500mm OD: 750mm	PSM206(RH) OH: 780mm OW: 1500mm OD: 750mm	PSM207(LH) OH: 780mm OW: 1500mm OD: 750mm
			
PSP075H OH: 600mm OW: 250mm OD: 750mm	PSS042L OH: 450mm OW: 250mm OD: 750mm	PSS042H OH: 780mm OW: 420mm OD: 420mm	PSS042L OH: 1195mm OW: 420mm OD: 420mm

↓ Scan here to discover more



# Pause

Design by Allermuir Design Studio

86

87

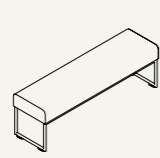
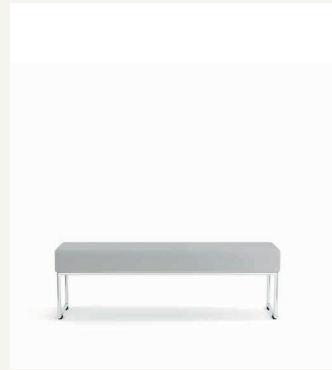

PSB154L - Low bench  
OH: 480mm  
OW: 1500mm

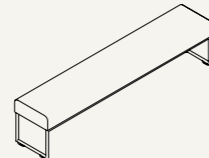

PSB214L - Low bench  
OH: 480mm  
OW: 2100mm

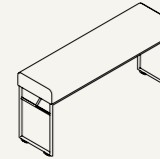

PSB154H - High bench  
OH: 720mm  
OW: 1500mm

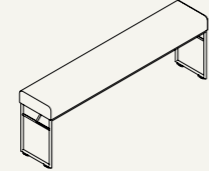

PSB214H - High bench  
OH: 720mm  
OW: 2100mm

## Pause - PSB154L Low bench 1500w

### Standard Features:

- Traditional carcass construction
- Tubular steel frame finished in Polished Chrome
- Plastic glides with levelling adjustment

### Optional Features:

- Multi-Fabrics

### Frame Finishes:

Polished Chrome 

For larger swatches go to pg.172-173

# Pebble

Design By Allermuir Design Studio

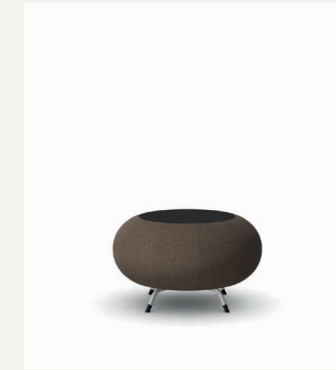
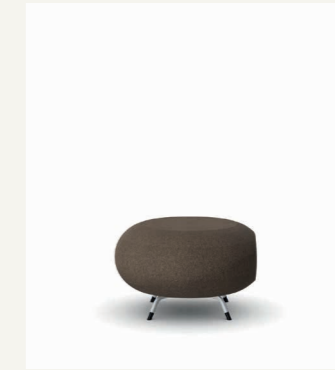
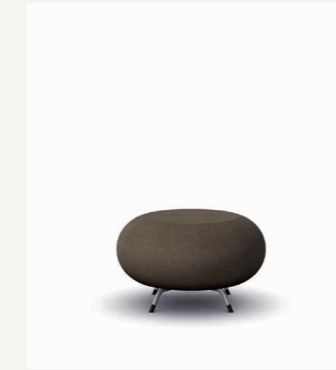

## Pebble - A620 Seat

### Dimensions:

Overall Height 430mm  
Diameter 730mm

### Standard Features:

- Moulded foam construction
- Webbed seat support
- Fully upholstered
- Tubular Steel leg finished in Silver powder coat
- Plastic glides

### Optional Features:

- Linking bracket
- Multi-Fabrics
- Decorative Railroad Stitch Detail in Black, White, Red, Light Grey, Dark Grey or Cream

### Frame Finishes:

Silver 

For larger swatches go to pg.172-173

## Pebble - A621 Scalloped Seat

### Dimensions:

Overall Height 430mm  
Diameter 730mm

### Standard Features:

- Moulded foam construction
- Webbed seat support
- Fully upholstered
- Tubular Steel leg finished in Silver powder coat
- Plastic glides

### Optional Features:

- Linking bracket
- Multi-Fabrics
- Decorative Railroad Stitch Detail in Black, White, Red, Light Grey, Dark Grey or Cream

### Frame Finishes:

Silver 

For larger swatches go to pg.172-173

## Pebble - A622 Table topped unit

### Dimensions:

Overall Height 430mm  
Diameter 730mm

### Standard Features:

- Moulded foam construction
- Laminate table top
- Tubular steel leg finished in Silver powder coat
- Plastic glides

### Optional Features:

- Linking bracket
- Decorative Railroad Stitch Detail in Black, White, Red, Light Grey, Dark Grey or Cream

### Frame Finishes:

Silver 

For larger swatches go to pg.172-173

16 optional Global Laminates are also available please go to pg. 135 to see more.

↓ Scan here to discover more



↓ Scan here to discover more

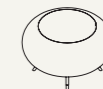

# Plum

Design By Mark Gabbertas

88

89

# Plum

Design By Mark Gabbertas

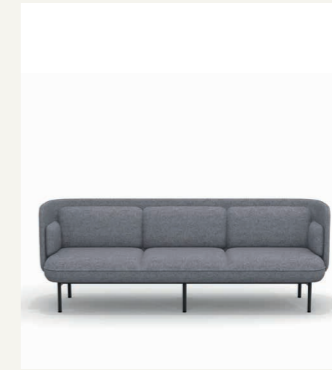
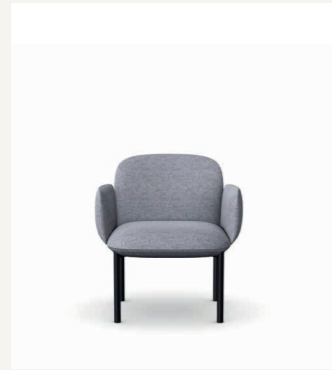

## Plum - PLM01 Lounge Chair

### Dimensions:

Seat Height	445mm
Seat Width	530mm
Seat Depth	490mm
Overall Height	775mm
Overall Width	600mm
Overall Depth	660mm

### Standard Features:

- Moulded foam construction
- Tubular Steel frame finished in Black powder coat
- Plastic glides

### Optional Features:

- Plastic glides with felt

### Frame Finishes:

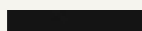
Black 

For larger swatches go to pg.172-173

## Plum - PLM02 Lounge Chair with Arms

### Dimensions:

Seat Height	445mm
Seat Width	490mm
Seat Depth	490mm
Overall Height	775mm
Overall Width	720mm
Overall Depth	660mm

### Standard Features:

- Moulded foam construction
- Moulded foam arms
- Tubular Steel frame finished in Black powder coat
- Plastic glides

### Optional Features:

- Plastic glides with felt

### Frame Finishes:

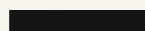
Black 

For larger swatches go to pg.172-173

## Plum - PLM100 1 Seat Sofa

### Dimensions:

Seat Height	460mm
Seat Width	845mm
Seat Depth	575mm
Overall Height	860mm
Overall Width	920mm
Overall Depth	750mm

### Standard Features:

- Moulded foam construction
- Moulded foam arms
- Fully Upholstered
- Tubular Steel back frame with foam overmold and tensioned fabric
- Tubular Steel frame finished in Black powder coat
- Plastic glides

### Optional Features:

- Plastic glides with felt
- Multi-Fabrics

### Frame Finishes:

Black 

For larger swatches go to pg.172-173

## Plum - PLM200 2 Seat Sofa

### Dimensions:

Seat Height	460mm
Seat Width	1595mm
Seat Depth	575mm
Overall Height	860mm
Overall Width	1670mm
Overall Depth	750mm

### Standard Features:

- Moulded foam construction
- Moulded foam arms
- Fully Upholstered
- Tubular Steel back frame with foam overmold and tensioned fabric
- Tubular Steel frame finished in Black powder coat
- Plastic glides

### Optional Features:

- Plastic glides with felt
- Multi-Fabrics

### Frame Finishes:

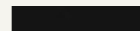
Black 

For larger swatches go to pg.172-173

## Plum - PLM300 3 Seat Sofa

### Dimensions:

Seat Height	460mm
Seat Width	2295mm
Seat Depth	575mm
Overall Height	860mm
Overall Width	2370mm
Overall Depth	750mm

### Standard Features:

- Moulded foam construction
- Moulded foam arms
- Fully Upholstered
- Tubular Steel back frame with foam overmold and tensioned fabric
- Tubular Steel frame finished in Black powder coat
- Plastic glides

### Optional Features:

- Plastic glides with felt
- Multi-Fabrics

### Frame Finishes:

Black 

For larger swatches go to pg.172-173



↓ Scan here to discover more



↓ Scan here to discover more

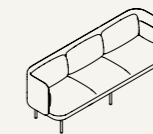
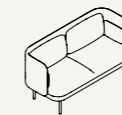

# Plum

Design By Mark Gabbertas

90

91

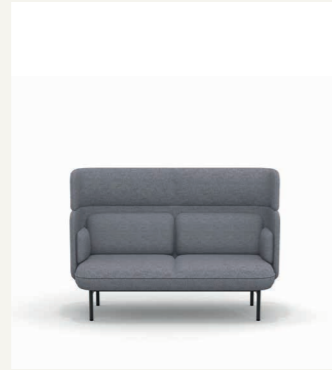
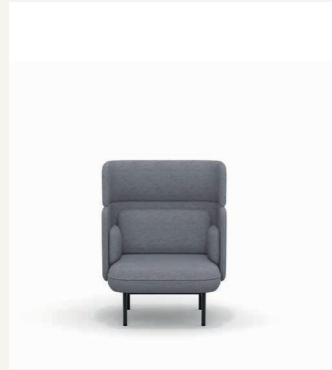

**Plum - PLM100HR**  
1 Seat Sofa with Headrest

**Dimensions:**

Seat Height	460mm
Seat Width	845mm
Seat Depth	575mm
Overall Height	1175mm
Overall Width	920mm
Overall Depth	750mm

**Standard Features:**

- Moulded foam construction
- Moulded foam arms
- Fully Upholstered
- Tubular Steel back frame with foam overmold and tensioned fabric
- Tubular Steel frame finished in Black powder coat
- Plastic glides

**Optional Features:**

- Plastic glides with felt
- Multi-Fabrics

**Frame Finishes:**

Black

For larger swatches go to pg.172-173

**Plum - PLM200HR**  
2 Seat Sofa with Headrest

**Dimensions:**

Seat Height	460mm
Seat Width	1595mm
Seat Depth	575mm
Overall Height	1175mm
Overall Width	1670mm
Overall Depth	750mm

**Standard Features:**

- Moulded foam construction
- Moulded foam arms
- Fully Upholstered
- Tubular Steel back frame with foam overmold and tensioned fabric
- Tubular Steel frame finished in Black powder coat
- Plastic glides

**Optional Features:**

- Plastic glides with felt
- Multi-Fabrics

**Frame Finishes:**

Black

For larger swatches go to pg.172-173

**Plum - PLM300HR**  
3 Seat Sofa with Headrest

**Dimensions:**

Seat Height	460mm
Seat Width	2295mm
Seat Depth	575mm
Overall Height	1175mm
Overall Width	2370mm
Overall Depth	750mm

**Standard Features:**

- Moulded foam construction
- Moulded foam arms
- Fully Upholstered
- Tubular Steel back frame with foam overmold and tensioned fabric
- Tubular Steel frame finished in Black powder coat
- Plastic glides

**Optional Features:**

- Plastic glides with felt
- Multi-Fabrics

**Frame Finishes:**

Black

For larger swatches go to pg.172-173

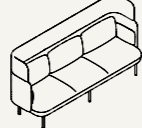
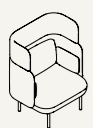

↓ Scan here to discover more



↓ Scan here to discover more



# Plum

Design By Mark Gabbertas



**Pebble - PLM101**  
1 Seat Ottoman

**Dimensions:**

Seat Height	460mm
Seat Width	845mm
Seat Depth	710mm

**Standard Features:**

- Moulded foam construction
- Moulded foam arms
- Fully Upholstered
- Tubular Steel frame finished in Black powder coat
- Plastic glides

**Optional Features:**

- Plastic glides with felt

**Frame Finishes:**

Black

For larger swatches go to pg.172-173

**Pebble - PLM201**  
2 Seat Ottoman

**Dimensions:**

Seat Height	460mm
Seat Width	1595mm
Seat Depth	710mm

**Standard Features:**

- Moulded foam construction
- Moulded foam arms
- Fully Upholstered
- Tubular Steel frame finished in Black powder coat
- Plastic glides

**Optional Features:**

- Plastic glides with felt

**Frame Finishes:**

Black

For larger swatches go to pg.172-173

**Pebble - PLM301**  
3 Seat Ottoman

**Dimensions:**

Seat Height	460mm
Seat Width	2295mm
Seat Depth	710mm

**Standard Features:**

- Moulded foam construction
- Moulded foam arms
- Fully Upholstered
- Tubular Steel frame finished in Black powder coat
- Plastic glides

**Optional Features:**

- Plastic glides with felt

**Frame Finishes:**

Black

For larger swatches go to pg.172-173

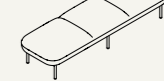

# Qu

Design By Allermuir Design Studio

92



## Qu - CUB02 Fully Upholstered Stool

### Dimensions:

Overall Height 460mm  
Overall Width 500mm  
Overall Depth 500mm

### Standard Features:

- Traditional carcass construction
- Deep quilted upholstery
- Plastic glides

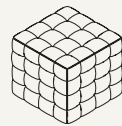

Design By Allermuir Design Studio

92

93

# Tarry

Design By Wolfgang C. R. Mezger



## Tarry - TAR403 Wing lounge chair with wood legs

### Dimensions:

Seat Height 430mm  
Seat Width 545mm  
Seat Depth 520mm  
Overall Height 1225mm  
Overall Width 740mm  
Overall Depth 815mm

### Standard Features:

- Moulded foam construction with dual density back foam
- Height adjustable headrest
- Fully upholstered
- Solid Ash legs with a clear finish
- Plastic glides

### Optional Features:

- Solid Ash legs can be stained or colour washed
- Plastic glides with felt
- Multi-Fabrics

### Wood Stains based on Ash:

Clear   
White Oak   
American Cherry   
American Walnut   
Dark Walnut   
Wenge 

For larger swatches go to pg.177

16 optional Ash colour washes are also available please go to pg. 178 to see more.



## Tarry - TAR404 Wing chair on a 4 star swivel base

### Dimensions:

Seat Height 460mm  
Seat Width 545mm  
Seat Depth 520mm  
Overall Height 1260mm  
Overall Width 740mm  
Overall Depth 815mm







### Standard Features:

- Moulded foam construction with dual density back foam
- Height adjustable headrest
- Free floating seat tilt with upright locking
- Fully upholstered
- 4 star Aluminium auto return swivel blade base finished in New Black powder coat
- Plastic glides

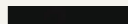
### Optional Features:

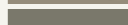
- 4 Star auto return swivel base available in Polished Aluminium and a selection of powder coat finishes
- Multi-Fabrics

### Frame Finishes:

New Black   
White   
Soft Gold   
Soft Silver   
Dark Bronze   
Deep Mulberry   
Polished Aluminium 

For larger swatches go to pg.172-173

16 optional Ash colour washes are also available please go to pg. 178 to see more.

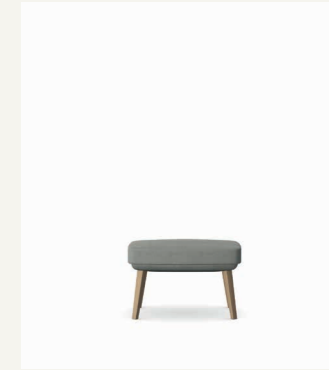

## Tarry - TARFS03 Footstool with wood legs

### Dimensions:

Overall Height 410mm  
Overall Width 615mm  
Overall Depth 460mm

### Standard Features:

- Fully upholstered
- Solid Ash legs with a clear finish
- Plastic glides

### Optional Features:

- Solid Ash legs can be stained or colour washed
- Plastic glides with felt
- Multi-Fabrics

### Wood Stains based on Ash:

Clear   
White Oak   
American Cherry   
American Walnut   
Dark Walnut   
Wenge 

For larger swatches go to pg.177

16 optional Ash colour washes are also available please go to pg. 178 to see more.



↓ Scan here to discover more



↓ Scan here to discover more



# Tylus

Design By Allermuir Design Studio

94



## Tylus - TYL400H Soft square cushion with grab handle

### Standard Features:

- Curled feather filled cushion with fire retardant inner cover
- Lines, Aztec, Echo or Flow Quilt detail options available
- Saddle leather grab handle available in Black, Natural or Dark Tan on select models
- Zipper available in Gold, Rose Gold, Silver or Black

For Quilting and Finish swatches go to pg. 188-189



TYL525 - Soft rectangle  
OH: 500mm  
OW: 250mm

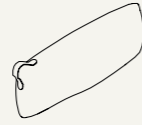

TYL525H - Soft rectangle with grab handle  
OH: 500mm  
OW: 250mm



TYL400 - Soft square  
OH: 400mm  
OW: 400mm



TYL400H - Soft square with grab handle  
OH: 400mm  
OW: 400mm



TYL500 - Soft square  
OH: 500mm  
OW: 500mm

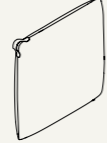

TYL500H - Soft square with grab handle  
OH: 500mm  
OW: 500mm



TYL600 - Soft square  
OH: 600mm  
OW: 600mm



TYL600H - Soft square with grab handle  
OH: 600mm  
OW: 600mm

# Cushions

Design By Allermuir Design Studio

95



## Loose Cushion - AMSCS Small square cushion

### Standard Features:

- Fire retardant inner cushion cover
- Soft fill stuffing
- Twinned edge stitching detail
- Panelled sides available on AMSCRD only

### Optional Features:

- Two-tone upholstery
- Twinned edge detail (TW) a twin needle stitch detail around perimeter, with zip to one side
- Piped edge detail (PP) piping detail around perimeter, with zip to one side.
- Added option of two-tone colour on piped detail edge only
- Zipped edge detail (ZL) reverse zip detail around whole perimeter
- Plain face detail (PL)
- Single button face detail (SB)
- Multi button face detail (MB)
- Quilted face detail (QU)

\*Add the two letter prefix for the Edge Detail and Face Detail to your cushion code when ordering

For all Cushion Edge and Face Details go to pg.187

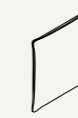

AMSCS - Small square  
OH: 400mm  
OW: 400mm



AMSCM - Medium square  
OH: 480mm  
OW: 480mm



AMSCS - Large square  
OH: 560mm  
OW: 560mm

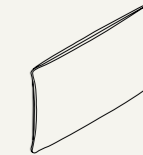

AMSCBL - Bolster cushion  
OH: 560mm  
OW: 350mm



AMSCRD - Round cushion  
D: 350mm

↓ Scan here to discover more



↓ Scan here to discover more







## Contents

100	Mayze
102	Obris
103	Orai
104	Oran
106	Paver
108	Plum
112	Stirling

# Mayze

Design by Allermuir Design Studio

100

101

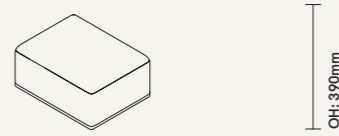

OH: 390mm

MZE01 - Ottoman  
SH: 390mm  
SW: 675mm  
SD: 875mm  
OW: 675mm  
OD: 875mm

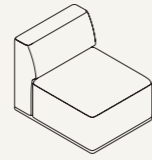

OH: 705mm

MZE02 - Single Seat  
SH: 390mm  
SW: 675mm  
SD: 675mm  
OW: 675mm  
OD: 875mm

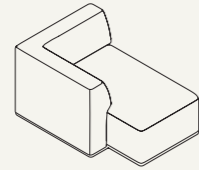

OH: 705mm

MZE04 - Chaise Seat (Right hand)  
SH: 390mm  
SW: 675mm  
SD: 1050mm  
OW: 875mm  
OD: 1250mm

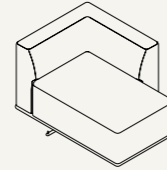

OH: 705mm

MZE05 - Chaise Seat (Left hand)  
SH: 390mm  
SW: 675mm  
SD: 1050mm  
OW: 875mm  
OD: 1250mm

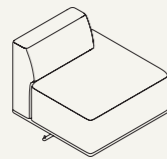

OH: 27.75" OH: 705mm

MZE06 - End Module Seat (Right hand)  
SH: 390mm  
SW: 675mm  
SD: 675mm  
OW: 675mm  
OD: 875mm

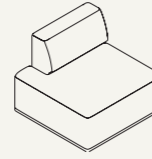

OH: 705mm

MZE07 - End Module Seat (Left hand)  
SH: 390mm  
SW: 675mm  
SD: 675mm  
OW: 675mm  
OD: 875mm

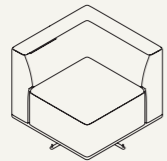

OH: 705mm

MZE08 - Corner Seat (Right hand)  
SH: 390mm  
SW: 675mm  
SD: 675mm  
OW: 875mm  
OD: 875mm

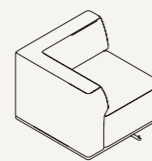

OH: 705mm

MZE09 - Corner Seat (Left hand)  
SH: 390mm  
SW: 675mm  
SD: 675mm  
OW: 875mm  
OD: 875mm

## Mayze

### Standard Features:

- Traditional carcass construction
- Tensioned seat support
- Seat to seat linking
- Felt glides

### Optional Features:

- Multi-Fabrics

## Configurations:

Create your own using our product configurator at [allermuir.com](http://allermuir.com)

1. MZE04  
MZE02 x 3  
MZE09  
MZE06

1

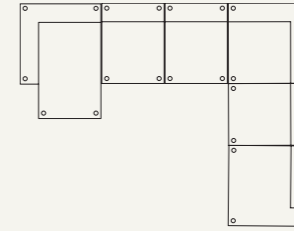

2

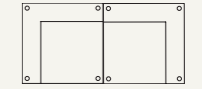

2. MZE08  
MZE09

3. MZE07 x 2  
MZE02 x 5  
MZE08  
MZE06

3

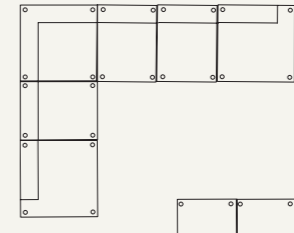

4

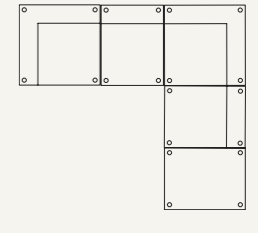

4. MZE08  
MZE02 x 2  
MZE09  
MZE01

5. MZE07  
MZE02 x 7  
MZE08  
MZE09  
MZE06

5

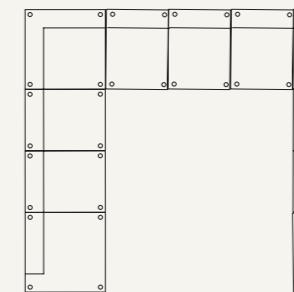

6

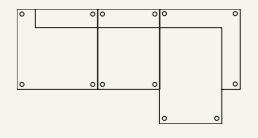

6. MZE07  
MZE02  
MZE05

7. MZE08  
MZE09  
MZE02 x 5  
MZE05

7

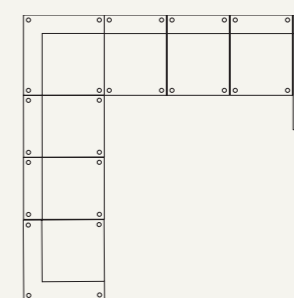

8



6. MZE08  
MZE02  
MZE09

↓ Scan here to discover more



# Obris

Design by Jonas Wagell

102

103

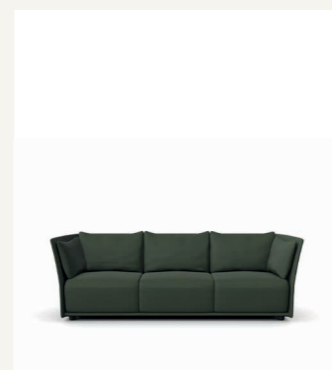
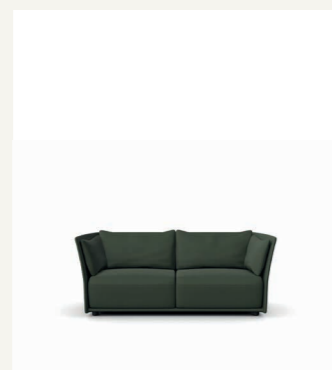
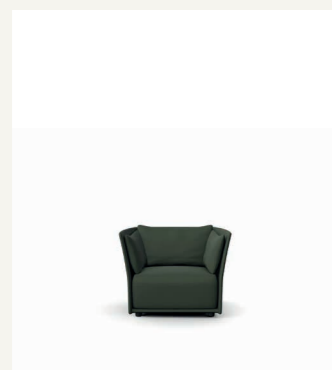

## Obris - OBR01 Arm Chair

### Dimensions:

Seat Height	415mm
Seat Width	785mm
Seat Depth	800mm
Overall Height	770mm
Overall Width	1000mm
Overall Depth	900mm

### Standard Features:

- Tubular Steel back frame with foam overmold and tensioned fabric
- Traditional carcass seat with dual density seat foam
- Foam core with feather and down back and arm cushions
- Solid Beech feet with a Black colour wash finish
- Reversible plastic/felt glides

## Obris - OBR02 2 Seater

### Dimensions:

Seat Height	415mm
Seat Width	1690mm
Seat Depth	800mm
Overall Height	770mm
Overall Width	1900mm
Overall Depth	900mm

### Standard Features:

- Tubular Steel back frame with foam overmold and tensioned fabric
- Traditional carcass seat with dual density seat foam
- Foam core with feather and down back and arm cushions
- Solid Beech feet with a Black colour wash finish
- Reversible plastic/felt glides

## Obris - OBR03 3 Seater

### Dimensions:

Seat Height	415mm
Seat Width	2085mm
Seat Depth	800mm
Overall Height	770mm
Overall Width	2300mm
Overall Depth	900mm

### Standard Features:

- Tubular Steel back frame with foam overmold and tensioned fabric
- Traditional carcass seat with dual density seat foam
- Foam core with feather and down back and arm cushions
- Solid Beech feet with a Black colour wash finish
- Reversible plastic/felt glides

# Orai

Design by Mark Gabbertas

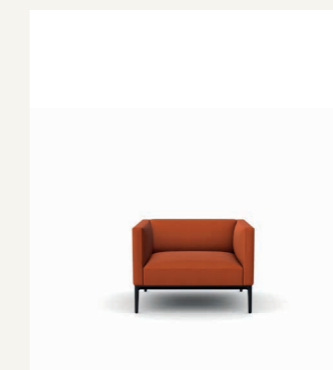

## Orai

### Standard Features:

- Fully upholstered
- Traditional carcass with multi-layered foam construction
- Tensioned seat support
- Cast Aluminium perimeter frame finished in Black (Textured) powder coat
- Plastic glides

### Optional Features:

- Plastic glides with felt

### Frame Finishes:

Black (Textured)

For larger swatches go to pg.172-173



Oh: 690mm

ORI100 - Armchair  
SH: 440mm  
SW: 690mm  
SD: 570mm  
OW: 960mm  
OD: 900mm

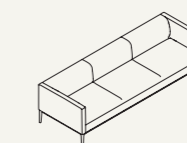

Oh: 690mm

ORI300 - 3 Seater Sofa  
SH: 440mm  
SW: 2330mm  
SD: 570mm  
OW: 2600mm  
OD: 900mm

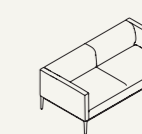

Oh: 690mm

ORI200 - 2 Seater Sofa  
SH: 440mm  
SW: 1570mm  
SD: 570mm  
OW: 1790mm  
OD: 900mm

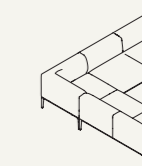

Oh: 690mm

ORI500 - Corner Unit  
SH: 440mm  
SD: 570mm  
OW: 2600mm  
OD: 2600mm

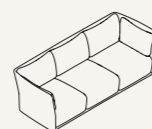
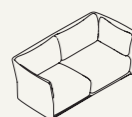
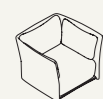

↓ Scan here to discover more



↓ Scan here to discover more



# Oran

Design by Mark Gabbertas

104

105

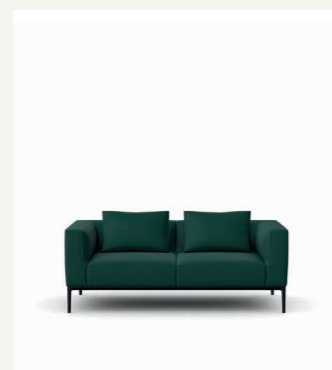
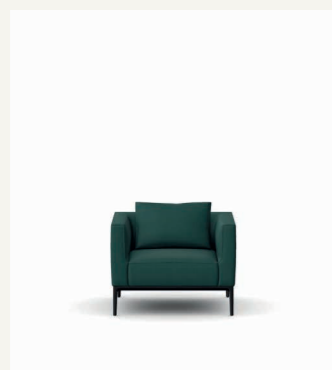

## Oran - ORA100 Arm Chair

### Dimensions:

Seat Height	440mm
Seat Width	735mm
Seat Depth	735mm
Overall Height	700mm
Overall Width	955mm
Overall Depth	940mm

### Standard Features:

- Fully Upholstered
- Traditional carcass construction
- Tensioned seat support
- Feather webbed sprung seat foam
- Curled feather filled cushion with fire retardant inner cover
- Cast Aluminium legs and Aluminium perimeter frame finished in Black [Textured] powder coat
- Plastic glides

### Optional Features:

- Multi-Fabrics

### Frame Finishes:

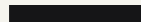
Black [Textured] 

For larger swatches go to pg.172-173

## Oran - ORA200 2 Seater Sofa

### Dimensions:

Seat Height	440mm
Seat Width	1470mm
Seat Depth	735mm
Overall Height	700mm
Overall Width	1865mm
Overall Depth	940mm

### Standard Features:

- Fully Upholstered
- Traditional carcass construction
- Tensioned seat support
- Feather webbed sprung seat foam
- Curled feather filled cushion with fire retardant inner cover
- Cast Aluminium legs and Aluminium perimeter frame finished in Black [Textured] powder coat
- Plastic glides

### Optional Features:

- Multi-Fabrics

### Frame Finishes:

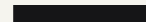
Black [Textured] 

For larger swatches go to pg.172-173

## Oran - ORA300 3 Seater Sofa

### Dimensions:

Seat Height	440mm
Seat Width	2205mm
Seat Depth	735mm
Overall Height	700mm
Overall Width	2600mm
Overall Depth	940mm

### Standard Features:

- Fully Upholstered
- Traditional carcass construction
- Tensioned seat support
- Feather webbed sprung seat foam
- Curled feather filled cushion with fire retardant inner cover
- Cast Aluminium legs and Aluminium perimeter frame finished in Black [Textured] powder coat
- Plastic glides

### Optional Features:

- Multi-Fabrics

### Frame Finishes:

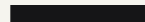
Black [Textured] 

For larger swatches go to pg.172-173

# Oran

Design by Mark Gabbertas

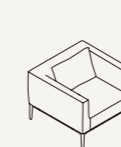

OH: 700mm

ORA100 - Armchair  
SH: 440mm  
SW: 735mm  
SD: 735mm  
OW: 955mm  
OD: 940mm



OH: 700mm

ORA200 - 2 Seat Sofa  
SH: 440mm  
SW: 1470mm  
SD: 735mm  
OW: 1865mm  
OD: 940mm



OH: 700mm

ORA250 - 2 Seat Sofa - wide  
SH: 440mm  
SW: 1820mm  
SD: 735mm  
OW: 2600mm  
OD: 940mm

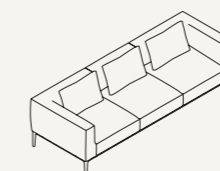

OH: 700mm

ORA300 - 3 Seat Sofa  
SH: 440mm  
SW: 2205mm  
SD: 735mm  
OW: 2600mm  
OD: 940mm

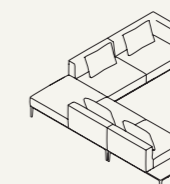

OH: 700mm

ORA502 - L shape unit with table  
SH: 440mm  
SD: 735mm  
OW: 3150mm  
OD: 2980mm

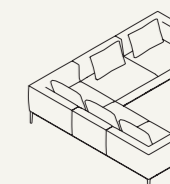

OH: 700mm

ORA500 - L shape sofa  
SH: 440mm  
SD: 735mm  
OW: 2600mm  
OD: 2805mm

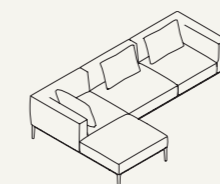

OH: 700mm

ORA503 - Right hand chaise sofa  
SH: 440mm  
SD: 735mm  
OW: 2805mm  
OD: 1690mm

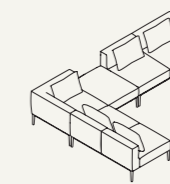

OH: 700mm

ORA501 - L shape Unit  
SH: 440mm  
SD: 735mm  
OW: 2600mm  
OD: 2805mm

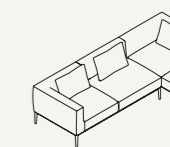

OH: 700mm

ORA504 - Left hand chaise sofa  
SH: 440mm  
SD: 735mm  
OW: 2805mm  
OD: 1690mm

↓ Scan here to discover more



# Paver

Design by Allermuir Design Studio

106

107



## Paver

### Standard Features:

- Traditional carcass construction
- Super soft foam upholstery
- Turned out top sewn seam
- Linking device
- Plastic glides

### Optional Features:

- Two-tone upholstery



PVRA650 - Arm  
OW: 650mm  
OD: 325mm

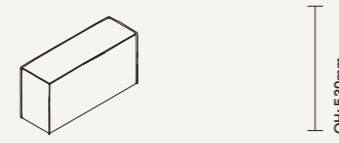

PVRA975 - Arm  
OW: 975mm  
OD: 325mm

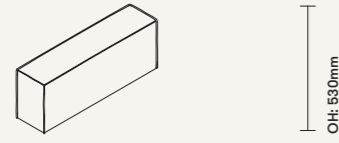

PVRA1300 - Arm  
OW: 1300mm  
OD: 325mm

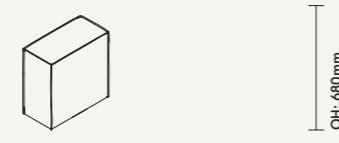

PVRB650 - Back  
OW: 650mm  
OD: 325mm

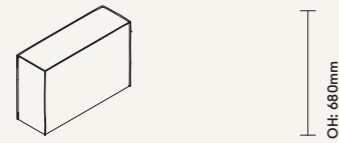

PVRB975 - Back  
OW: 975mm  
OD: 325mm

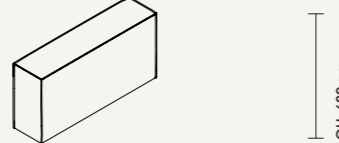

PVRB1300 - Back  
OW: 1300mm  
OD: 325mm

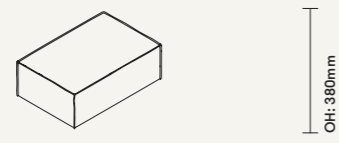

PVRS975 - Rectangular Seat  
OW: 975mm  
OD: 650mm

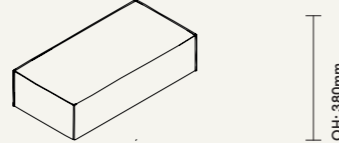

PVRS1300 - Rectangular Seat  
OW: 1300mm  
OD: 650mm

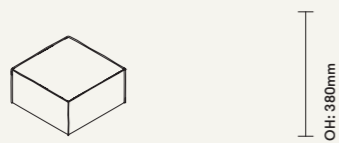

PVRS650SQ - Square Seat  
OW: 650mm  
OD: 650mm

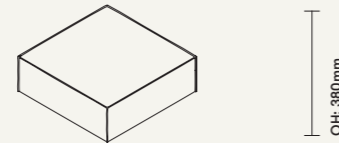

PVRS975SQ - Square Seat  
OW: 975mm  
OD: 975mm

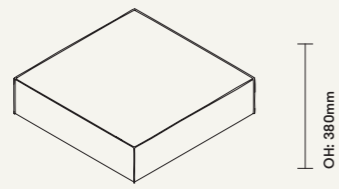

PVRS1300SQ - Square Seat  
OW: 1300mm  
OD: 1300mm

## Configurations:

Create your own using our product configurator at [allermuir.com](http://allermuir.com)

1. PVRS975 x 3  
PVRB650 x 2  
PVRB975 x 2  
PVRS1300  
PVRA975

1

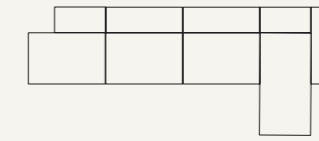

2

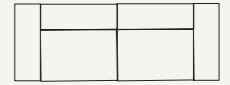

2. PVRS975 x 2  
PVRB975 x 2  
PVRA975 x 2

3. PVRA975  
PVRB650 x 6  
PVRA975 x 2  
PVRB975

3

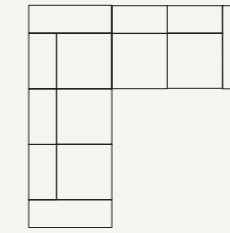

4

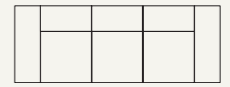

4. PVRS650SQ x 3  
PVRB650 x 3  
PVRA975 x 2

5. PVRS1300  
PVRS975 x 4  
PVRB975 x 3  
PVRS975SQ x 2  
PVRS650SQ  
PVRA975

5

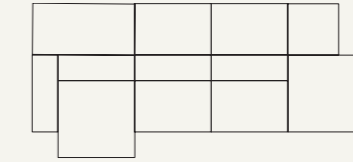

6

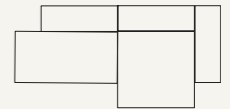

6. PVRS1300  
PVRB975 x 2  
PVRA975  
PVRS975SQ

7. PVRA975 x 2  
PVRB1300 x 2  
PVRS1300  
PVRS650SQ x 3

7

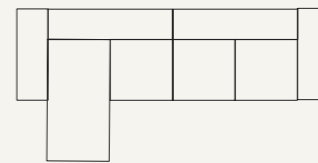

8

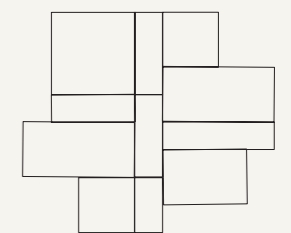

8. PVRS975SQ  
PVRB975 x 2  
PVRA975  
PVRS1300 x 2  
PVRA1300  
PVRB650  
PVRS650SQ x 2  
PVRS975

9. PVRS1300 x 2  
PVRS975  
PVRB1300 x 2  
PVRS1300SQ  
PVRB650  
PVRS650SQ  
PVRA650

9

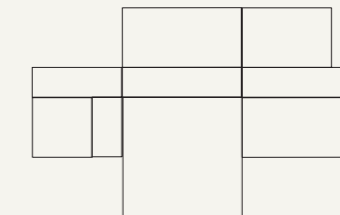

↓ Scan here to discover more



# Plum

Design By Mark Gabbertas

108

109

# Plum

Design By Mark Gabbertas



## Plum - PLM01 Lounge Chair

### Dimensions:

Seat Height	445mm
Seat Width	530mm
Seat Depth	490mm
Overall Height	775mm
Overall Width	600mm
Overall Depth	660mm

### Standard Features:

- Moulded foam construction
- Tubular Steel frame finished in Black powder coat
- Plastic glides

### Optional Features:

- Plastic glides with felt

### Frame Finishes:

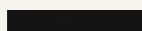
Black 

For larger swatches go to pg.172-173

## Plum - PLM02 Lounge Chair with Arms

### Dimensions:

Seat Height	445mm
Seat Width	490mm
Seat Depth	490mm
Overall Height	775mm
Overall Width	720mm
Overall Depth	660mm

### Standard Features:

- Moulded foam construction
- Moulded foam arms
- Tubular Steel frame finished in Black powder coat
- Plastic glides

### Optional Features:

- Plastic glides with felt

### Frame Finishes:

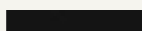
Black 

For larger swatches go to pg.172-173

## Plum - PLM100 1 Seat Sofa

### Dimensions:

Seat Height	460mm
Seat Width	845mm
Seat Depth	575mm
Overall Height	860mm
Overall Width	920mm
Overall Depth	750mm

### Standard Features:

- Moulded foam construction
- Moulded foam arms
- Fully Upholstered
- Tubular Steel back frame with foam overmold and tensioned fabric
- Tubular Steel frame finished in Black powder coat
- Plastic glides

### Optional Features:

- Plastic glides with felt
- Multi-Fabrics

### Frame Finishes:

Black 

For larger swatches go to pg.172-173

## Plum - PLM200 2 Seat Sofa

### Dimensions:

Seat Height	460mm
Seat Width	1595mm
Seat Depth	575mm
Overall Height	860mm
Overall Width	1670mm
Overall Depth	750mm

### Standard Features:

- Moulded foam construction
- Moulded foam arms
- Fully Upholstered
- Tubular Steel back frame with foam overmold and tensioned fabric
- Tubular Steel frame finished in Black powder coat
- Plastic glides

### Optional Features:

- Plastic glides with felt
- Multi-Fabrics

### Frame Finishes:

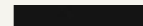
Black 

For larger swatches go to pg.172-173

## Plum - PLM300 3 Seat Sofa

### Dimensions:

Seat Height	460mm
Seat Width	2295mm
Seat Depth	575mm
Overall Height	860mm
Overall Width	2370mm
Overall Depth	750mm

### Standard Features:

- Moulded foam construction
- Moulded foam arms
- Fully Upholstered
- Tubular Steel back frame with foam overmold and tensioned fabric
- Tubular Steel frame finished in Black powder coat
- Plastic glides

### Optional Features:

- Plastic glides with felt
- Multi-Fabrics

### Frame Finishes:

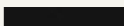
Black 

For larger swatches go to pg.172-173



↓ Scan here to discover more



↓ Scan here to discover more

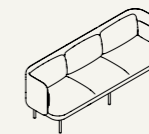
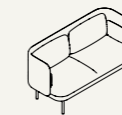

# Plum

Design By Mark Gabbertas

110

111

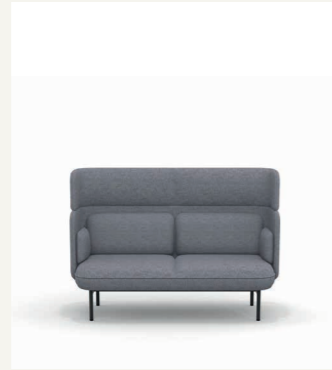
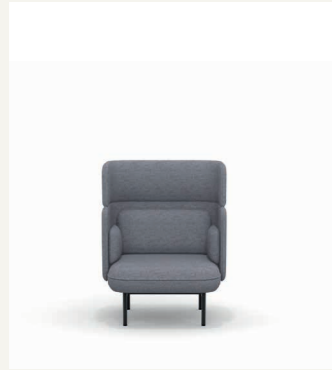

Plum - PLM100HR  
1 Seat Sofa with Headrest

**Dimensions:**

Seat Height	460mm
Seat Width	845mm
Seat Depth	575mm
Overall Height	1175mm
Overall Width	920mm
Overall Depth	750mm

**Standard Features:**

- Moulded foam construction
- Moulded foam arms
- Fully Upholstered
- Tubular Steel back frame with foam overmold and tensioned fabric
- Tubular Steel frame finished in Black powder coat
- Plastic glides

**Optional Features:**

- Plastic glides with felt
- Multi-Fabrics

**Frame Finishes:**

Black 

For larger swatches go to pg.172-173

Plum - PLM200HR  
2 Seat Sofa with Headrest

**Dimensions:**

Seat Height	460mm
Seat Width	1595mm
Seat Depth	575mm
Overall Height	1175mm
Overall Width	1670mm
Overall Depth	750mm

**Standard Features:**

- Moulded foam construction
- Moulded foam arms
- Fully Upholstered
- Tubular Steel back frame with foam overmold and tensioned fabric
- Tubular Steel frame finished in Black powder coat
- Plastic glides

**Optional Features:**

- Plastic glides with felt
- Multi-Fabrics

**Frame Finishes:**

Black 

For larger swatches go to pg.172-173

Plum - PLM300HR  
3 Seat Sofa with Headrest

**Dimensions:**

Seat Height	460mm
Seat Width	2295mm
Seat Depth	575mm
Overall Height	1175mm
Overall Width	2370mm
Overall Depth	750mm

**Standard Features:**

- Moulded foam construction
- Moulded foam arms
- Fully Upholstered
- Tubular Steel back frame with foam overmold and tensioned fabric
- Tubular Steel frame finished in Black powder coat
- Plastic glides

**Optional Features:**

- Plastic glides with felt
- Multi-Fabrics

**Frame Finishes:**

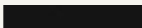
Black 

For larger swatches go to pg.172-173

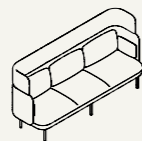
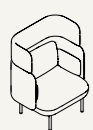

↓ Scan here to discover more



↓ Scan here to discover more



# Plum

Design By Mark Gabbertas

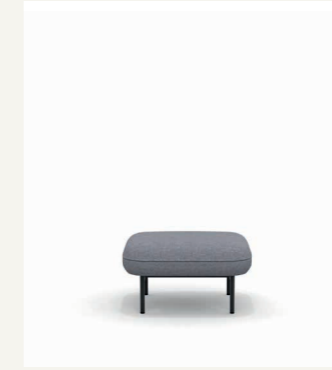

Plum - PLM101  
1 Seat Ottoman

**Dimensions:**

Seat Height	460mm
Seat Width	845mm
Seat Depth	710mm

**Standard Features:**

- Moulded foam construction
- Fully Upholstered
- Tubular Steel frame finished in Black powder coat
- Plastic glides

**Optional Features:**

- Plastic glides with felt

**Frame Finishes:**

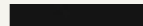
Black 

For larger swatches go to pg.172-173

Plum - PLM201  
2 Seat Ottoman

**Dimensions:**

Seat Height	460mm
Seat Width	1595mm
Seat Depth	710mm

**Standard Features:**

- Moulded foam construction
- Fully Upholstered
- Tubular Steel frame finished in Black powder coat
- Plastic glides

**Optional Features:**

- Plastic glides with felt

**Frame Finishes:**

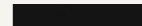
Black 

For larger swatches go to pg.172-173

Plum - PLM301  
3 Seat Ottoman

**Dimensions:**

Seat Height	460mm
Seat Width	2295mm
Seat Depth	710mm

**Standard Features:**

- Moulded foam construction
- Fully Upholstered
- Tubular Steel frame finished in Black powder coat
- Plastic glides

**Optional Features:**

- Plastic glides with felt

**Frame Finishes:**

Black 

For larger swatches go to pg.172-173

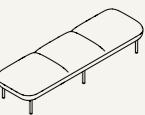





## Contents

116	Axyl
118	Batan
121	Cirque
123	Conic
124	Folk
125	Folk Environmental
126	FortySeven
132	FortySeven XL
135	Host
136	Oran
137	Pache
140	Silta
142	Sunda 1
143	Sunda 2
144	Tibo
145	Turo
146	Turo Environmental

114

115

# Tables

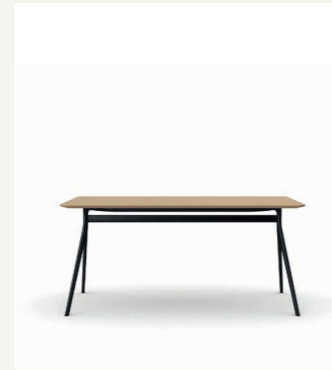
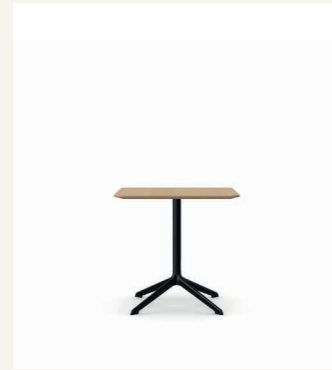
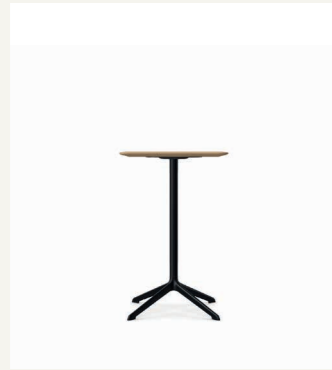

### Axyl Bistro High level table

Dimensions:  
Overall Height 1020mm

- Standard Features:
- 25mm Laminate faced MDF core top with a clear edge finish (Edge 38)
  - Cast Aluminium base and Aluminium centre column finished in Matt Black powder coat
  - Integral leg feet with levelling adjustment

- Optional Features:
- Cast Aluminium base and Aluminium centre column available in a selection of powder coat finishes
  - Table edge profile can be stained in a selection of colours

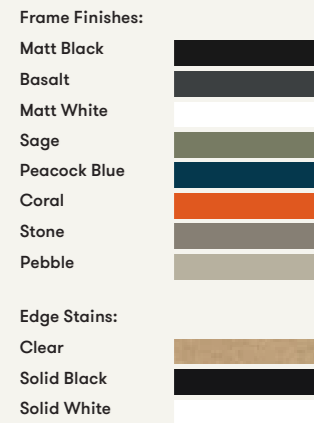

For larger swatches go to pg.172-183

8 optional Stock Laminates are also available please go to pg. 181 to see more.

### Axyl Bistro Dining table

Dimensions:  
Overall Height 740mm

- Standard Features:
- 25mm Laminate faced MDF core top with a clear edge finish (Edge 38)
  - Cast Aluminium base and Aluminium centre column finished in Matt Black powder coat
  - Integral leg feet with levelling adjustment

- Optional Features:
- Cast Aluminium base and Aluminium centre column available in a selection of powder coat finishes
  - Table edge profile can be stained in a selection of colours

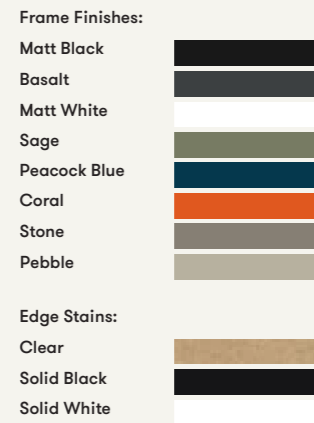

For larger swatches go to pg.172-183

8 optional Stock Laminates are also available please go to pg. 181 to see more.

### Axyl Dining Height table with rectangular top

Dimensions:  
Overall Height 740mm

- Standard Features:
- 25mm Laminate faced MDF core top with a clear edge finish (Edge 38)
  - Cast Aluminium base and Aluminium centre column finished in Matt Black powder coat
  - Integral leg feet with levelling adjustment
  - Inset legs at 300mm available on select models only

- Optional Features:
- Cast Aluminium base and Aluminium centre column available in a selection of powder coat finishes
  - Table edge profile can be stained in a selection of colours

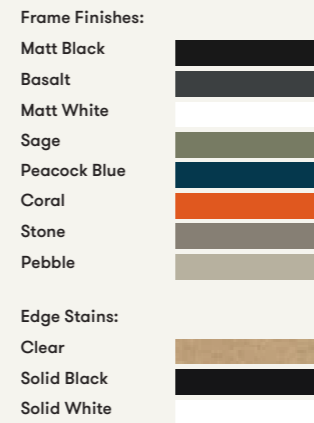

For larger swatches go to pg.172-183

8 optional Stock Laminates are also available please go to pg. 181 to see more.

### Bistro High

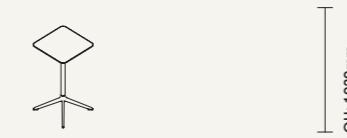

AXLH06SQ  
OW: 600mm  
OD: 600mm

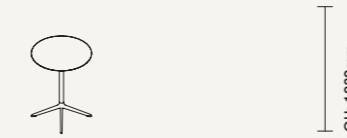

AXLH08RD  
Dia: 800mm



AXLH07SQ  
OW: 750mm  
OD: 750mm



### Bistro Dining



AXLD08RD  
Dia: 800mm



AXLD07SQ  
OW: 750mm  
OD: 750mm

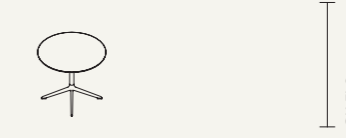

AXLD09RD  
Dia: 900mm



### Dining Height



AXLR1609  
OW: 1600mm  
OD: 900mm

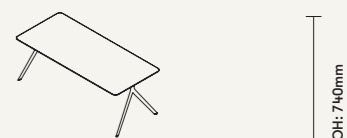
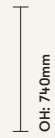

AXLR2009  
OW: 2000mm  
OD: 900mm

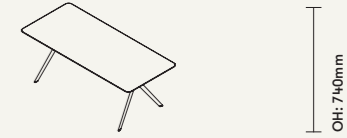
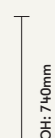

AXLR2009  
OW: 2000mm  
OD: 900mm

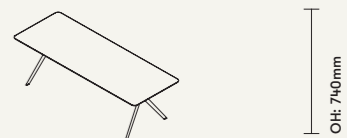
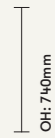

AXLR2409  
OW: 2400mm  
OD: 900mm

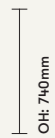

↓ Scan here to discover more



# Batan – Compact Plinth

Design by Allermuir Design Studio

118



## Low

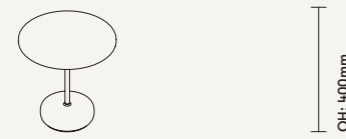

CPL04RDGLS  
Dia: 400mm

OH: 400mm

## Tall



CPH04RDGLS  
Dia: 400mm

OH: 600mm

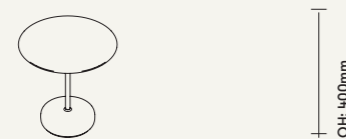

CPL04RDBRS  
Dia: 400mm

OH: 400mm



CPH04RDBRS  
Dia: 400mm



OH: 500mm

## Batan - Compact Plinth

### Standard Features:

- Concrete base in Natural finish
- Steel stem in Brass finish
- Frosted glass top in Beige finish
- Radial top in Brass finish

### Frame Finishes:

- Brass 
- Natural Concrete 

### Top Finishes:

- Radial brass 
- Frosted glass beige 

For larger swatches go to pg.175

119

# Batan – Extruded Blend

Design by Allermuir Design Studio



## Low



EBL07RD  
Dia: 700mm

OH: 325mm

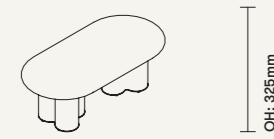

EBLP1005  
OW: 500mm  
OD: 1000mm

OH: 325mm

## Medium



EBM05RD  
Dia: 500mm

OH: 350mm

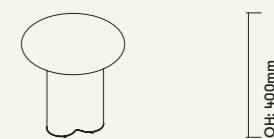

EBH05RD  
Dia: 500mm

OH: 400mm

## Batan - Extruded Blend





### Standard Features:

- Aluminium extruded frame in a selection of powder coat finishes
- 20mm thick White Marble top
- 20mm thick Green Marble top
- 20mm thick Terazzo top
- 20mm thick Oak top in lacquer



### Optional Features:

- 20mm thick Oak top in black or blue stain



### Leg / Frame Finishes:

- Black [Textured] 
- Mineral Forest 
- Ultramarine Blue 
- Ceramic White 
- White [Textured] 
- Soft Gold 

### Solid Stone Finishes:

- Green marble 
- White marble 
- Terrazzo 

### Solid Timber:

- Clear on Oak 
- Black Oak Stain 
- Blue Oak Stain 

For larger swatches go to pg.175-177

↓ Scan here to discover more



↓ Scan here to discover more



# Batan – Soft Folds

Design by Allermuir Design Studio

120









## Batan - Soft Folds

### Standard Features:

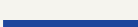
- Folded steel frame and formed steel top finished in a selection of powder coat finishes
- Colour matched levelling feet

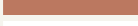
### Frame Finishes:

Black (Textured)	
Forest Green (Textured)	
Ultramarine Blue	
Blush	
White (Textured)	
Ivory	

For larger swatches go to pg.172-173

### Low

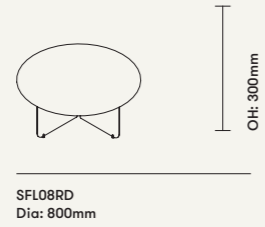

### Medium

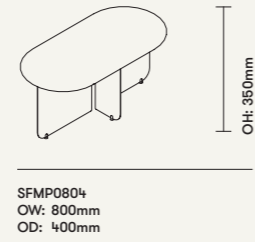
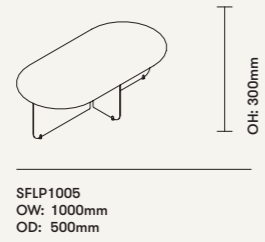

### Tall

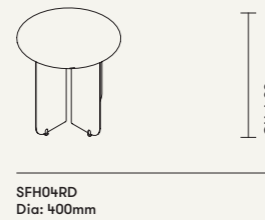

# Cirque

Design by Allermuir Design Studio

121



## Cirque

### Standard Features:

- 25mm Laminate faced MDF core top with a clear edge finish (Edge 37)
- Solid Ash legs with a clear finish
- Steel subframe finished in Slate Grey powder coat
- Plastic glides

### Optional Features:

- Table edge profile can be stained in a selection of colours
- Solid Ash legs can be stained or colour washed

### Frame Finishes:

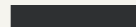
Slate Grey 

### Solid Wood Leg Finishes:

Clear on Ash 

### Wood Stains based on Ash:

Clear	
White Oak	
American Cherry	
American Walnut	
Dark Walnut	
Wenge	

### Edge Stains:

Clear	
Solid Black	
Solid White	

For larger swatches go to pg.173-183

8 optional Stock Laminates, 16 Colour Washes based on Ash are also available please go to pg. 178 - 181 to see more.

### Low

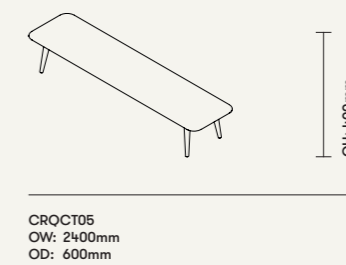
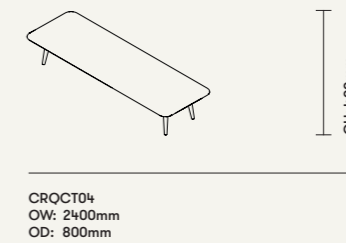
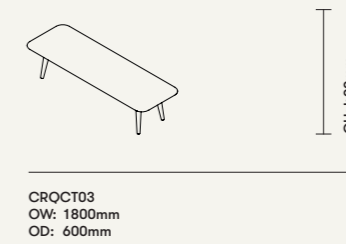
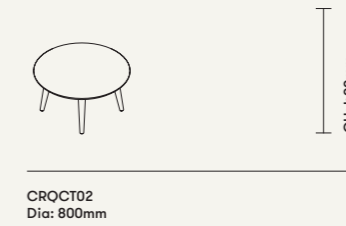
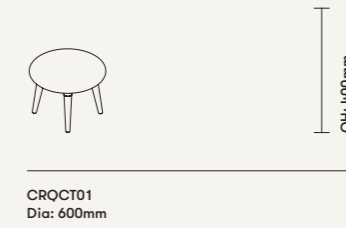

↓ Scan here to discover more



↓ Scan here to discover more



# Cirque

Design by Allermuir Design Studio

122

123

# Conic

Design by Pearson Lloyd



## Dining - Round



CRODT01  
Dia: 600mm

## Dining - Soft Square



CRODT05  
OW: 600mm  
OD: 600mm

## Dining - Soft Rectangle



CRODT09  
OW: 1200mm  
OD: 800mm

## Cirque

### Standard Features:

- 25mm Laminate faced MDF core top with a clear edge finish (Edge 37)
- Solid Ash legs with a clear finish
- Steel subframe finished in Slate Grey powder coat
- Plastic glides

### Optional Features:

- Table edge profile can be stained in a selection of colours
- Solid Ash legs can be stained or colour washed

### Frame Finishes:

Slate Grey

### Solid Wood Leg Finishes:

Clear on Ash

### Wood Stains based on Ash:

Clear

White Oak

American Cherry

American Walnut

Dark Walnut

Wenge

### Edge Stains:

Clear

Solid Black

Solid White

For larger swatches go to pg.173-183

8 optional Stock Laminates, 16 Colour Washes based on Ash are also available please go to pg. 178 - 181 to see more.



CRODT02  
Dia: 800mm



CRODT06  
OW: 800mm  
OD: 800mm



CRODT10  
OW: 1800mm  
OD: 1000mm



CRODT03  
Dia: 1000mm



CRODT07  
OW: 1000mm  
OD: 1000mm



CRODT11  
OW: 2400mm  
OD: 1000mm



CRODT04  
Dia: 1200mm



CRODT08  
OW: 1200mm  
OD: 1200mm

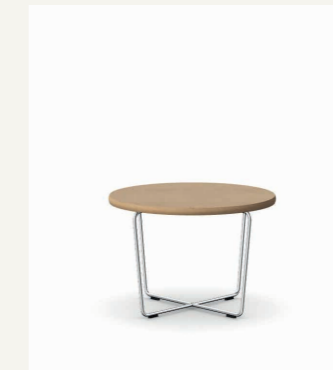

## Round



A638-6RD  
Dia: 600mm

## Soft Square

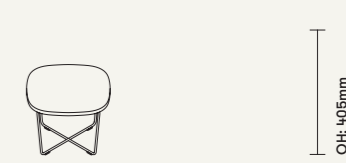

A638-6SS  
OW: 540mm  
OD: 540mm

## Conic

### Standard Features:

- 25mm Laminate faced MDF core top with a clear edge finish (Edge 37)
- 25mm MFC top with matching edge tape (TE)
- Wire frame finished in Polished Chrome
- Plastic glides

### Optional Features:

- Table edge profile can be stained in a selection of colours
- Wire frame available in a selection of colours

### Frame Finishes:

Polished Chrome

New Black

White

Soft Gold

Soft Silver

Dark Bronze

Deep Mulberry

### Edge Stains:

Clear (Standard)

Solid Black

Solid White

For larger swatches go to pg.173-183

8 optional Stock Laminates, 12 MFC Finishes are also available please go to pg. 181-182 to see more.



A638-9RD  
Dia: 900mm

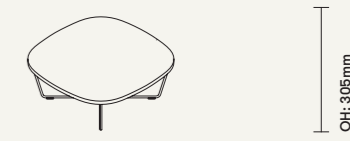

A638-8SS  
OW: 800mm  
OD: 800mm

## Soft Rectangle



A638-107S  
OW: 1050mm  
OD: 700mm

↓ Scan here to discover more



↓ Scan here to discover more



# Folk

Design by Pearson Lloyd

124

125

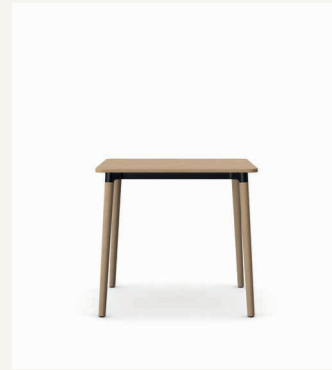

## Dining - Circular



FLK10RD  
Dia: 1000mm

## Dining - Square



FLK08SQ  
OW: 800mm  
OD: 800mm

### Folk

#### Standard Features:

- 18mm Laminate faced MDF core top with a 2mm contrast edge tape
- 18mm Laminate faced Plywood core top with a clear finish exposed edge detail [33]
- Aluminium corner joint and Steel frame under structure finished in Off Black powder coat
- Solid Ash legs with a clear finish
- Plastic glides with levelling adjustment

#### Optional Features:

- Aluminium corner joint and Steel framework available in a selection of powder coat finishes
- Solid Ash legs can be colour washed or stained in a selection of colours

#### Frame Finishes



#### Wood Stains based on Ash:



#### Colour Washes based on Ash:

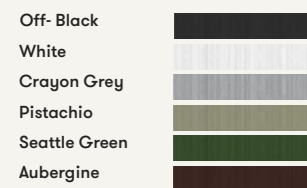

For larger swatches go to pg.172-178

16 optional Global Laminates are also available please go to pg. 131 to see more.



FLK12RD  
Dia: 1200mm



FLK12SQ  
OW: 1200mm  
OD: 1200mm

## Dining - Rectangular

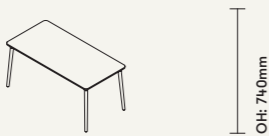

FLK1608RC  
OW: 1600mm  
OD: 800mm



FLK2209RC  
OW: 2200mm  
OD: 900mm

# Folk Environmental

Design by Pearson Lloyd

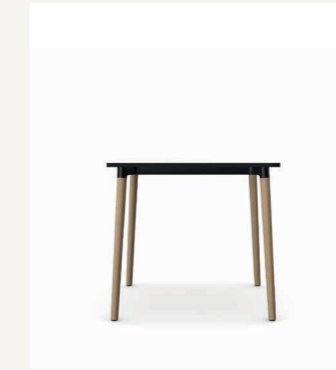

## Dining - Circular

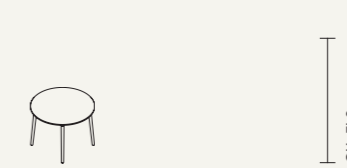

FLK10RDR  
Dia: 1000mm

## Dining - Square

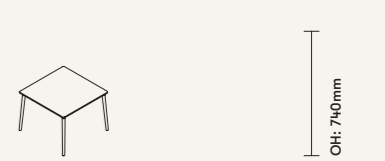

FLK10SQR  
OW: 1000mm  
OD: 1000mm

### Folk

#### Standard Features:

- 18mm Cotton Cream Kvadrat Really Board with Cream 2mm edge tape
- Aluminium Fluted legs and Steel frame under structure finished in Black powder coat
- Plastic glides with levelling adjustment

#### Optional Features:

- 18mm Cotton White Kvadrat Really Board with Black 2mm edge tape
- 18mm Cotton Blue Kvadrat Really Board with Oak effect 2mm edge tape
- Aluminium Fluted legs and Steel frame under structure available in White, Sage or Pebble powder coat

#### Top Finishes:

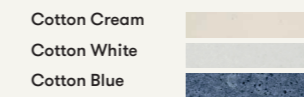

#### Edge Finishes:



#### Frame Finishes:

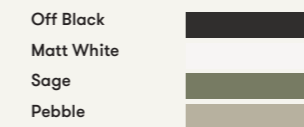

For larger swatches go to pg.172-182

↓ Scan here to discover more



↓ Scan here to discover more



# FortySeven

Design by Allermuir Design Studio

126

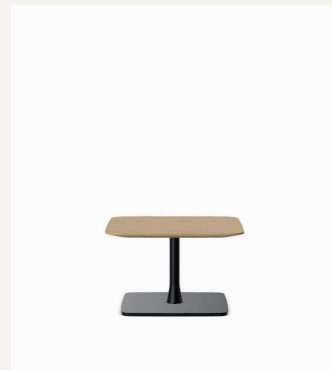

## Coffee Height - Circular

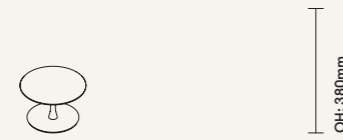

FRSC06RD  
Dia: 600mm

## Coffee Height - Square

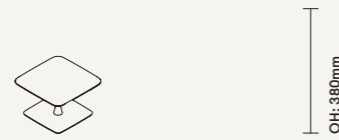

FRSC06SQ  
OW: 600mm  
OD: 600mm



FRSC07RD  
Dia: 750mm

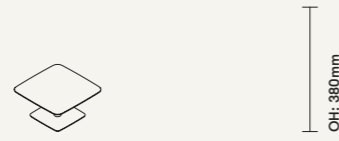

FRSC07SQ  
OW: 750mm  
OD: 750mm

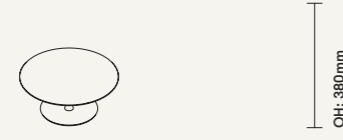

FRSC09RD  
Dia: 900mm

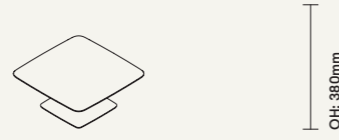

FRSC09SQ  
OW: 900mm  
OD: 900mm

### Fortyseven Coffee height table

Dimensions:  
Overall Height 380mm

#### Standard Features:

- 25mm Laminate faced MDF core top with a clear edge profile (Edge 38)
- 25mm Laminate faced MDF core top with a contrast edge tape (TE)
- 25mm MFC top with a matching edge tape
- Steel pedestal base finished in Matt Black powder coat
- Plastic glides with levelling adjustment

#### Optional Features:

- Steel pedestal base available in a selection colours
- Table edge profile can be stained in a selection of colours

#### Frame Finishes:

Matt Black	
Matt White	
Stone	

#### Edge Stains:

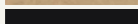
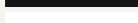
Clear (Standard)	
Solid Black	
Solid White	

For larger swatches go to pg.172-183

12 MFC Finishes and 8 optional Stock Laminates are also available please go to pg. 181-182 to see more.

↓ Scan here to discover more



127

# FortySeven

Design by Allermuir Design Studio

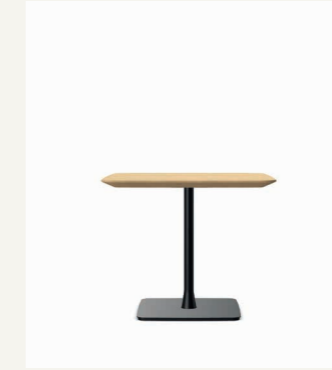

### Fortyseven Work Lounge table

Dimensions:  
Overall Height 640mm



#### Standard Features:

- 25mm Laminate faced MDF core top with a clear edge profile (Edge 38)
- 25mm Laminate faced MDF core top with a contrast edge tape (TE)
- 25mm MFC top with a matching edge tape
- Steel pedestal base finished in Matt Black powder coat
- Plastic glides with levelling adjustment

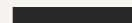
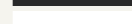

#### Optional Features:

- Steel pedestal base available in a selection colours
- Table edge profile can be stained in a selection of colours

#### Frame Finishes:

Matt Black	
Matt White	
Stone	

#### Edge Stains:

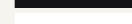
Clear (Standard)	
Solid Black	
Solid White	

For larger swatches go to pg.172-183

12 MFC Finishes and 8 optional Stock Laminates are also available please go to pg. 181-182 to see more.

↓ Scan here to discover more



## Work Lounge



FRSW07RD  
Dia: 750mm



FRSW07SQ  
OW: 750mm  
OD: 750mm

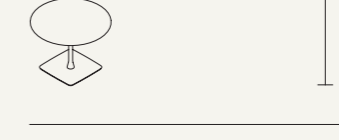

FRSW09RD  
Dia: 900mm

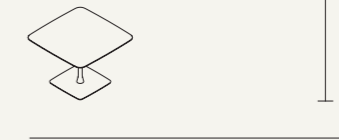

FRSW09SQ  
OW: 900mm  
OD: 900mm



# FortySeven

Design by Allermuir Design Studio

128

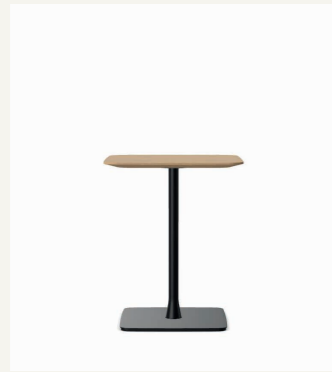

## Dining

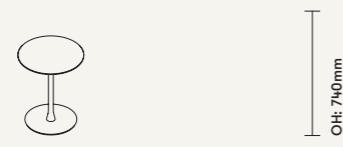

FRSD06RD  
Dia: 600mm

OH: 740mm

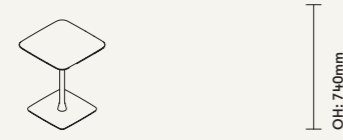

FRSD06SQ  
OW: 600mm  
OD: 600mm

OH: 740mm

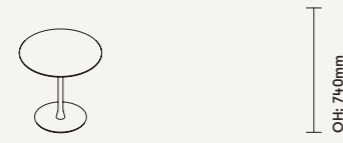

FRSD07RD  
Dia: 750mm

OH: 740mm

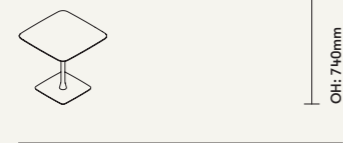

FRSD07SQ  
OW: 750mm  
OD: 750mm

OH: 740mm

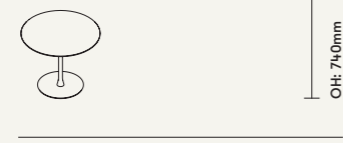

FRSD09RD  
Dia: 900mm

OH: 740mm



FRSD09SQ  
OW: 900mm  
OD: 900mm

OH: 740mm

### Fortyseven Dining height table

#### Dimensions:

Overall Height 740mm

#### Standard Features:

- 25mm Laminate faced MDF core top with a clear edge profile (Edge 38)
- 25mm Laminate faced MDF core top with a contrast edge tape (TE)
- 25mm MFC top with a matching edge tape
- Steel pedestal base finished in Matt Black powder coat
- Plastic glides with levelling adjustment

#### Optional Features:

- Steel pedestal base available in a selection of colours
- Table edge profile can be stained in a selection of colours

#### Frame Finishes:



#### Edge Stains:

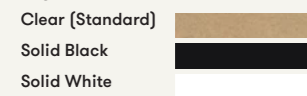

For larger swatches go to pg.172-183

12 MFC Finishes and 8 optional Stock Laminates are also available please go to pg. 181-182 to see more.

↓ Scan here to discover more



↓ Scan here to discover more



# FortySeven

Design by Allermuir Design Studio

129



### Fortyseven Dining table with rectangular top

#### Dimensions:

Overall Height 740mm

#### Standard Features:

- 25mm Laminate faced MDF core top with a clear edge profile (Edge 38)
- 25mm Laminate faced MDF core top with a contrast edge tape (TE)
- 25mm MFC top with a matching edge tape
- Steel pedestal base finished in Matt Black powder coat
- Plastic glides with levelling adjustment

#### Optional Features:

- Steel pedestal base available in a selection of colours
- Table edge profile can be stained in a selection of colours

#### Frame Finishes:

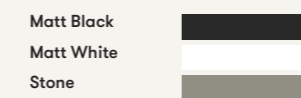

#### Edge Stains:

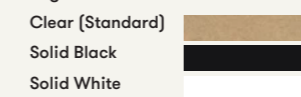

For larger swatches go to pg.172-183

12 MFC Finishes and 8 optional Stock Laminates are also available please go to pg. 181-182 to see more.

## Dining Rectangular

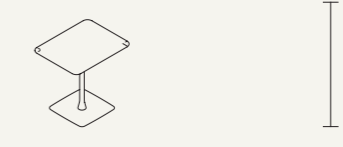

FRSD0706RC  
OW: 750mm  
OD: 600mm

OH: 740mm

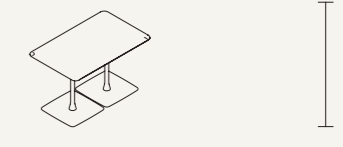

FRSD1209RC  
OW: 1200mm  
OD: 900mm

OH: 740mm

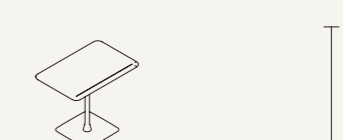

FRSD0906RC  
OW: 900mm  
OD: 600mm

OH: 740mm

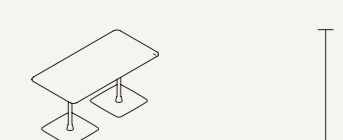

FRSD1507RC  
OW: 1500mm  
OD: 750mm

OH: 740mm

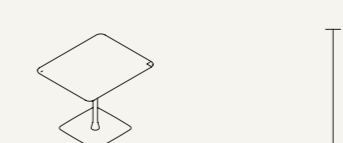

FRSD0907RC  
OW: 900mm  
OD: 750mm

OH: 740mm

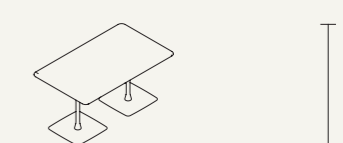

FRSD1509RC  
OW: 1500mm  
OD: 900mm

OH: 740mm



FRSD1007RC  
OW: 1000mm  
OD: 750mm

OH: 740mm

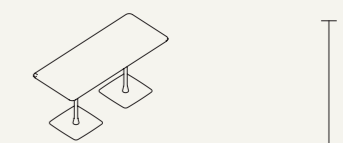

FRSD1807RC  
OW: 1800mm  
OD: 750mm

OH: 740mm

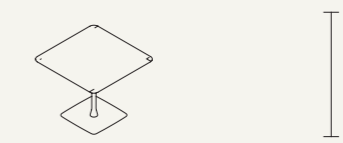

FRSD1009RC  
OW: 1000mm  
OD: 900mm

OH: 740mm

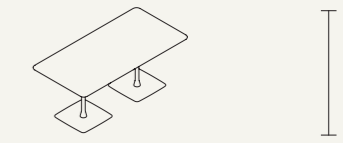

FRSD1809RC  
OW: 1800mm  
OD: 900mm

OH: 740mm

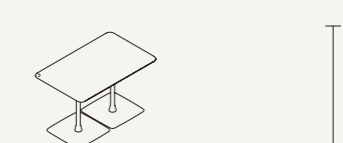

FRSD1207RC  
OW: 1200mm  
OD: 750mm

OH: 740mm

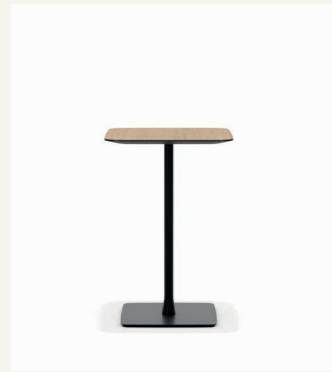

## Counter Height

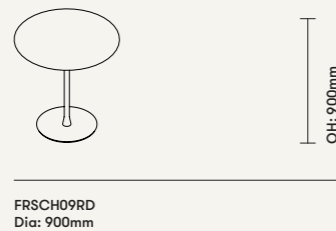
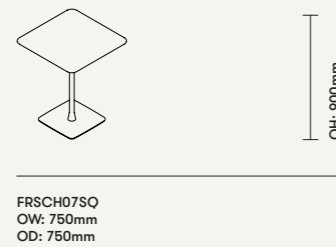
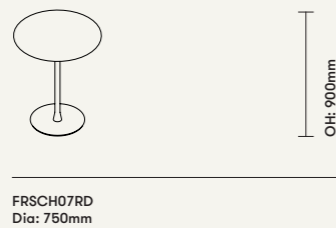
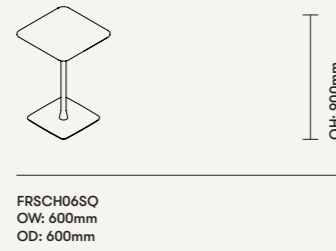
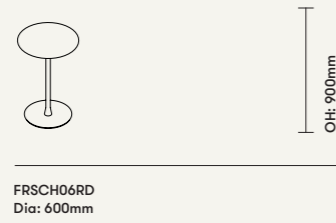

### Fortyseven Counter height table

Dimensions:  
Overall Height 900mm

- Standard Features:
- 25mm Laminate faced MDF core top with a clear edge profile [Edge 38]
  - 25mm Laminate faced MDF core top with a contrast edge tape (TE)
  - 25mm MFC top with a matching edge tape
  - Steel pedestal base finished in Matt Black powder coat
  - Plastic glides with levelling adjustment

- Optional Features:
- Steel pedestal base available in a selection colours
  - Table edge profile can be stained in a selection of colours

- Frame Finishes:
- Matt Black
  - Matt White
  - Stone

- Edge Stains:
- Clear (Standard)
  - Solid Black
  - Solid White

For larger swatches go to pg.172-183

12 MFC Finishes and 8 optional Stock Laminates are also available please go to pg. 181-182 to see more.

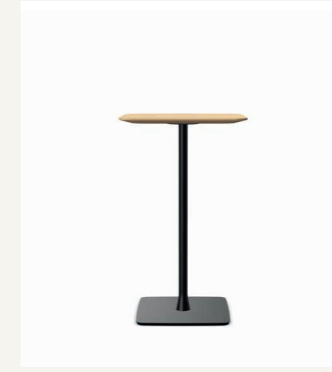

## High

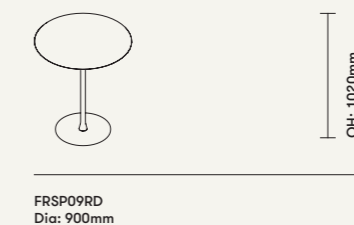
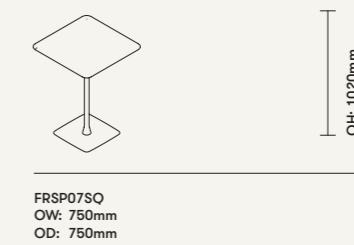
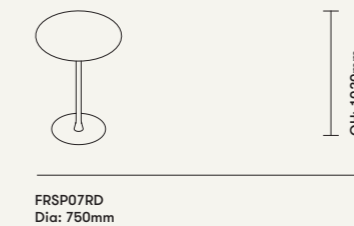
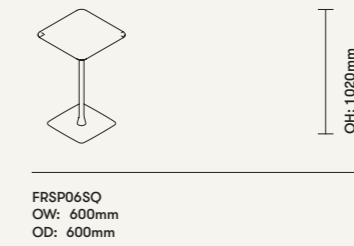
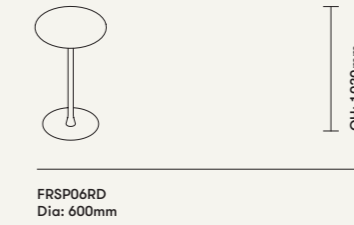

### Fortyseven High level table

Dimensions:  
Overall Height 1020mm

- Standard Features:
- 25mm Laminate faced MDF core top with a clear edge profile [Edge 38]
  - 25mm Laminate faced MDF core top with a contrast edge tape (TE)
  - 25mm MFC top with a matching edge tape
  - Steel pedestal base finished in Matt Black powder coat
  - Plastic glides with levelling adjustment

- Optional Features:
- Steel pedestal base available in a selection colours
  - Table edge profile can be stained in a selection of colours

- Frame Finishes:
- Matt Black
  - Matt White
  - Stone

- Edge Stains:
- Clear (Standard)
  - Solid Black
  - Solid White

For larger swatches go to pg.172-183

12 MFC Finishes and 8 optional Stock Laminates are also available please go to pg. 181-182 to see more.

↓ Scan here to discover more



↓ Scan here to discover more



# FortySeven XL

Design by Allermuir Design Studio

132

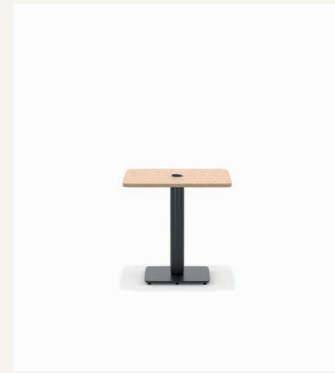

## XL Work Lounge

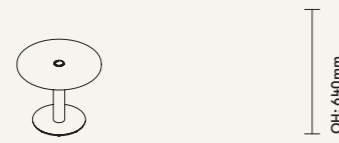

FRSXW07RD  
Dia: 750mm

OH: 640mm



FRSXW07SQ  
OW: 750mm  
OD: 750mm

OH: 640mm

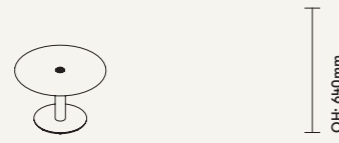

FRSXW09RD  
Dia: 900mm

OH: 640mm

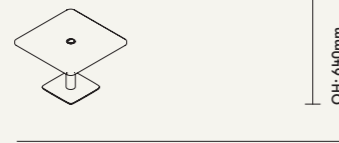

FRSXW09SQ  
OW: 900mm  
OD: 900mm

OH: 640mm

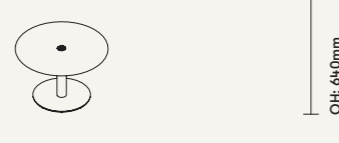

FRSXW10RD  
Dia: 1000mm

OH: 640mm

### Fortyseven XL Work lounge table

#### Dimensions:

Overall Height 640mm

#### Standard Features:

- 25mm Laminate faced MDF core top with a clear edge profile (Edge 38)
- 25mm Laminate faced MDF core top with a contrast edge tape (TE)
- 25mm MFC top with a matching edge tape
- Steel pedestal base finished in Matt Black powder coat
- Plastic glides with levelling adjustment
- Black cable port

#### Optional Features:

- Steel pedestal base available in a selection of colours
- Table edge profile can be stained in a selection of colours
- Central power option including ×1 UK socket, ×1 TUF 25W A+C USB, ×1 UK starter cable

#### Frame Finishes:



#### Edge Stains:

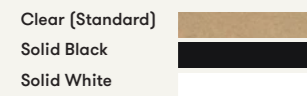

For larger swatches go to pg.172-183

12 MFC Finishes and 8 optional Stock Laminates are also available please go to pg. 181-182 to see more.

↓ Scan here to discover more



↓ Scan here to discover more



# FortySeven XL

Design by Allermuir Design Studio

133

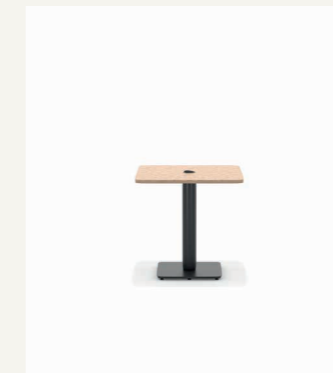

## XL Dining



FRSXLD07RD  
Dia: 750mm

OH: 740mm



FRSXLD12RD  
Dia: 1200mm

OH: 740mm

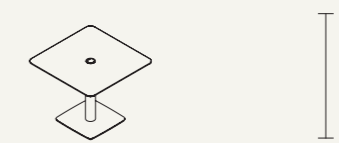

FRSXLD07SQ  
OW: 750mm  
OD: 750mm

OH: 740mm

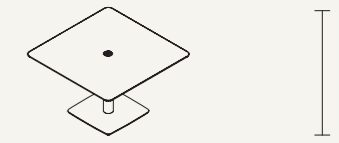

FRSXLD12SQ  
OW: 1200mm  
OD: 1200mm

OH: 740mm



FRSXLD09RD  
Dia: 900mm

OH: 740mm



FRSXLD09SQ  
OW: 900mm  
OD: 900mm

OH: 740mm



FRSXLD10RD  
Dia: 1000mm

OH: 740mm

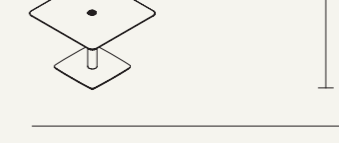

FRSXLD10SQ  
OW: 1000mm  
OD: 1000mm

OH: 740mm

### Fortyseven XL Dining height table

#### Dimensions:

Overall Height 740mm

#### Standard Features:

- 25mm Laminate faced MDF core top with a clear edge profile (Edge 38)
- 25mm Laminate faced MDF core top with a contrast edge tape (TE)
- 25mm MFC top with a matching edge tape
- Steel pedestal base finished in Matt Black powder coat
- Plastic glides with levelling adjustment
- Black cable port

#### Optional Features:

- Steel pedestal base available in a selection of colours
- Table edge profile can be stained in a selection of colours
- Central power option including ×1 UK socket, ×1 TUF 25W A+C USB, ×1 UK starter cable

#### Frame Finishes:

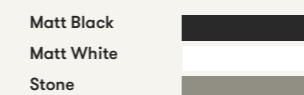

#### Edge Stains:

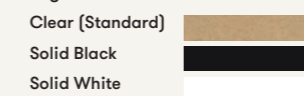

For larger swatches go to pg.172-183

12 MFC Finishes and 8 optional Stock Laminates are also available please go to pg. 181-182 to see more.

# FortySeven XL

Design by Allermuir Design Studio

134

135

# Host

Design by Simon Pengelly

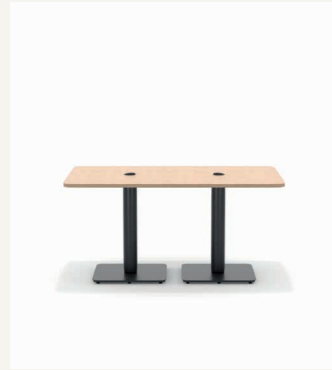

## XL Dining Rectangular

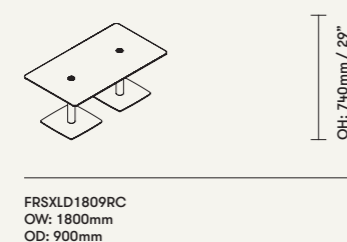
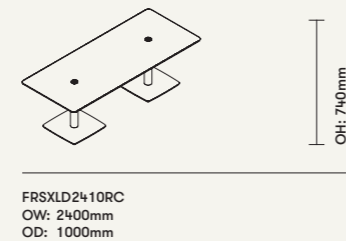
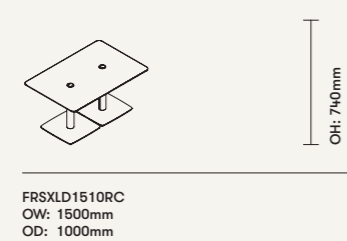
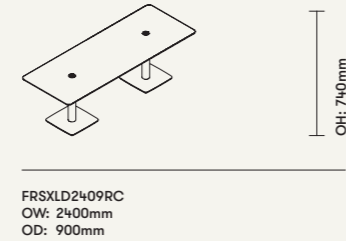
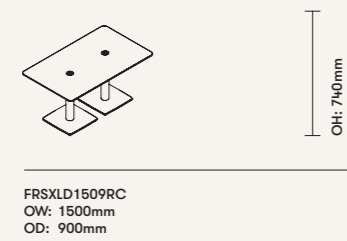
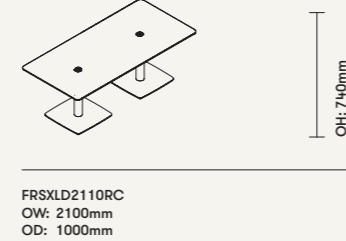
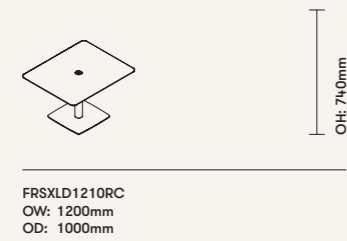
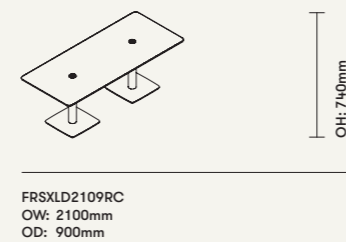
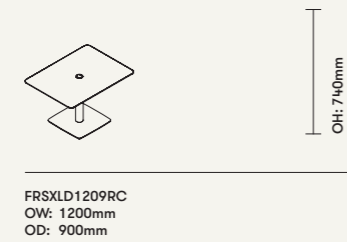
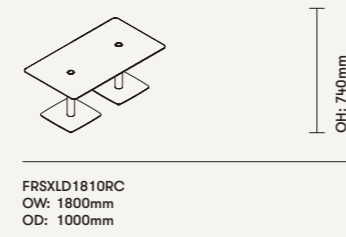
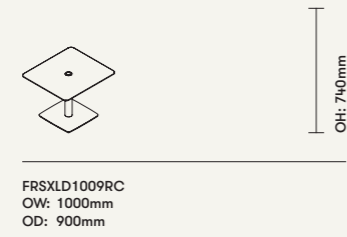

### Fortyseven XL Dining table with rectangular top

Dimensions:  
Overall Height 740mm

#### Standard Features:

- 25mm Laminate faced MDF core top with a clear edge profile (Edge 38)
- 25mm Laminate faced MDF core top with a contrast edge tape (TE)
- 25mm MFC top with a matching edge tape
- Steel pedestal base finished in Matt Black powder coat
- Plastic glides with levelling adjustment
- Black cable port (x2 on larger tables)

#### Optional Features:

- Steel pedestal base available in a selection colours
- Table edge profile can be stained in a selection of colours
- Central power option including x1 UK socket, x1 TUF 25W A+C USB, x1 UK starter cable

#### Frame Finishes:

- Matt Black
- Matt White
- Stone

#### Edge Stains:

- Clear (Standard)
- Solid Black
- Solid White

For larger swatches go to pg.172-183

12 MFC Finishes and 8 optional Stock Laminates are also available please go to pg. 181-182 to see more.

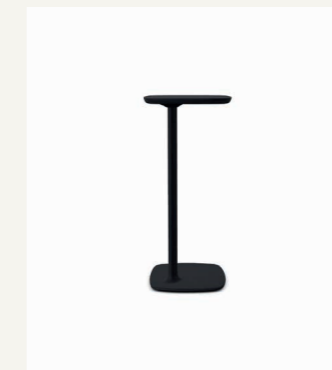

### Host — HLT2 Occasional table

Dimensions:  
Overall Height 600mm  
Overall Width 347mm  
Overall Depth 347mm

#### Standard Features:

- Aluminium table construction available in a selection of colours
- Teflon glides

#### Finishes:

- Black (Textured)
- Touch of Grey
- White as Snow
- Blue Skies
- Mellow Yellow
- Orange Crush
- Vintage Red

For larger swatches go to pg.172-173

↓ Scan here to discover more



↓ Scan here to discover more



# Oran

Design by Mark Gabbertas

136

137

# Pache

Design by Allermuir Design Studio

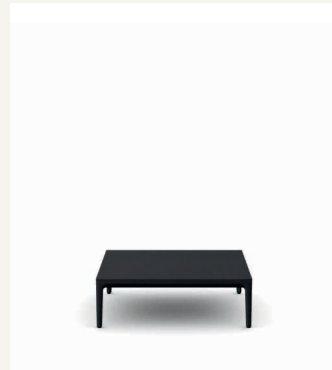

## Coffee Height



ORAT7373  
OW: 735mm  
OD: 735mm

OH: 240mm

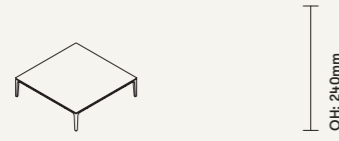

ORAT9191  
OW: 910mm  
OD: 910mm

OH: 240mm

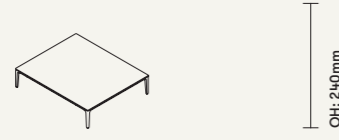

ORAT1091  
OW: 1085mm  
OD: 910mm

OH: 240mm

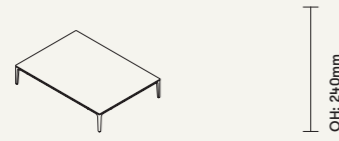

ORAT1291  
OW: 1260mm  
OD: 910mm

OH: 240mm

## Oran Coffee Table

### Standard Features:

- Laminate faced MDF core top available in Matt Black or Tusk Grey
- Cast Aluminium legs and Aluminium perimeter frame finished in Black (Textured) powder coat
- Plastic glides

### Frame Finishes:

Black (Textured) 

### Matt Laminate:

Black 

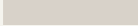
Tusk Grey 

For larger swatches go to pg.172-180



## Dining - Round



PAC90RD  
Dia: 900mm

OH: 740mm



PAC100RD  
Dia: 1000mm

OH: 740mm



PAC120RD  
Dia: 1200mm

OH: 740mm

## Dining - Square



PAC9090  
OW: 900mm  
OD: 900mm

OH: 740mm



PAC1010  
OW: 1000mm  
OD: 1000mm

OH: 740mm



PAC1212  
OW: 1200mm  
OD: 1200mm

OH: 740mm

## Pache Dining Height Table



### Standard Features:

- 25mm Laminate faced MDF core top with a clear edge profile (Edge 46)
- Solid ash legs with a clear finish
- Aluminium framework available in Black powder coat
- Plastic glides

### Optional Features:

- Table edge profile can be stained
- Aluminium framework available in a selection of powder coat finishes
- Solid Ash legs available in Black colour wash

### Edge Stains:

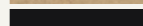
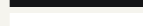
- Plywood Clear 
- Clear 
- Solid Black 
- Solid White 

### Frame Finishes:

- White 
- Black 
- Stone 

### Wood Finish:

- Clear on Ash 

### Colour Wash based on Ash:

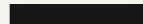
- Black 

For larger swatches go to pg.172-178

8 optional Stock Laminates are also available please go to pg. 181 to see more.

↓ Scan here to discover more



↓ Scan here to discover more



# Pache

Design by Allermuir Design Studio

138



## Dining - Rectangular



PAC1280R  
OW: 1200mm  
OD: 800mm

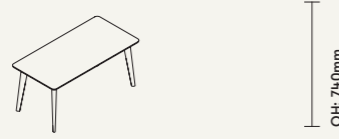

PAC1608R  
OW: 1600mm  
OD: 800mm

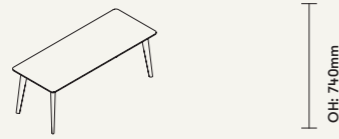

PAC2008R  
OW: 2000mm  
OD: 800mm

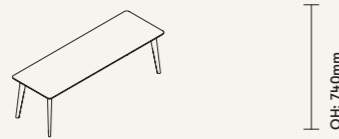

PAC2408R  
OW: 2400mm  
OD: 800mm

### Pache Dining Height Table with a Rectangular Top





#### Standard Features:

- 25mm Laminate faced MDF core top with a clear edge profile
- Solid ash legs with a clear finish
- Aluminium framework available in Black powder coat
- Plastic glides

#### Optional Features:

- Table edge profile can be stained
- Aluminium framework available in a selection of powder coat finishes
- Solid Ash legs available in Black colour wash

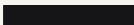
#### Edge Stains:

- Plywood Clear 
- Clear 
- Solid Black 
- Solid White 

#### Frame Finishes:

- White 
- Black 
- Stone 

#### Wood Finish:

- Clear on Ash 

#### Colour Wash based on Ash:

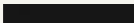
- Black 

For larger swatches go to pg.172-178

8 optional Stock Laminates are also available please go to pg. 181 to see more.

# Pache

Design by Allermuir Design Studio

139



## Dining - Soft Chamfered Rectangle

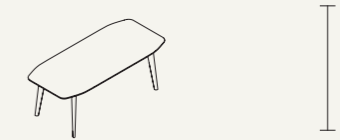

PAC2009SC  
OW: 2000mm  
OD: 900mm

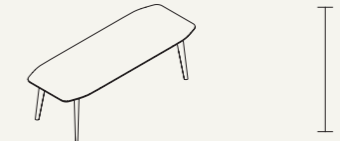

PAC2409SC  
OW: 2400mm  
OD: 900mm



PAC3209SC  
OW: 3200mm  
OD: 900mm

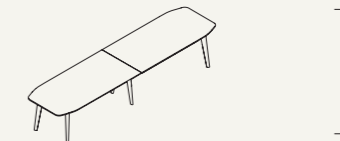

PAC3609SC  
OW: 3600mm  
OD: 900mm



PAC4009SC  
OW: 4000mm  
OD: 900mm

### Pache Dining Height Table with a Soft Chamfered Rectangle top





#### Standard Features:

- 25mm Laminate faced MDF core top with a clear edge profile
- Solid ash legs with a clear finish
- Aluminium framework available in Black powder coat
- Plastic glides

#### Optional Features:

- Table edge profile can be stained
- Aluminium framework available in a selection of powder coat finishes
- Solid Ash legs available in Black colour wash

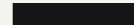
#### Edge Stains:

- Plywood Clear 
- Clear 
- Solid Black 
- Solid White 

#### Frame Finishes:

- White 
- Black 
- Stone 

#### Wood Finish:

- Clear on Ash 

#### Colour Wash based on Ash:

- Black 

For larger swatches go to pg.172-178

8 optional Stock Laminates are also available please go to pg. 181 to see more.

↓ Scan here to discover more



↓ Scan here to discover more



# Silta

Design by Allermuir Design Studio

140

141

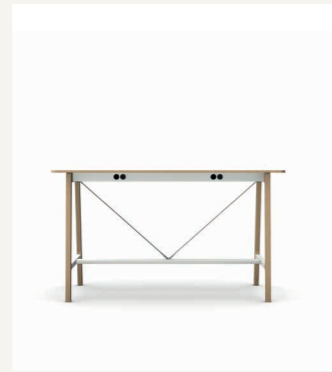
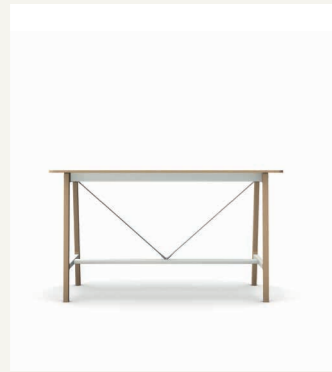

## Silta High Level Table

### Standard Features:

- 18mm Laminate faced Plywood core top with a clear finish, exposed edge detail (Edge 33)
- 18mm Linoleum faced Plywood core top with a clear finish, exposed edge detail, available in a selection of colours (Edge 33)
- 12mm solid surface top available in cloud (Edge 41)
- Solid Ash legs with a clear finish
- Tubular Steel framework finished in White powder coat
- Brushed Steel tie bars
- Brushed Aluminium bag hooks (x2)

### Optional Features:

- Solid Ash legs can be stained or colour washed
- Tubular Steel framework available in a selection of powder coat finishes

### Frame Finishes:



### Linoleum:



### Solid Surface Finish:

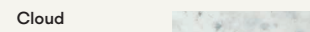

### Edge Stain:

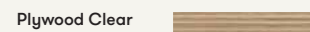

### Wood Finish:

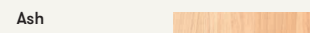

### Colour Washes based on Ash:



For larger swatches go to pg.172-183

8 Stock Laminates and 6 Wood Stains based on Ash are also available please go to pg. 177 - 181 to see more.

## Silta High Level Table with Power

### Standard Features:

- 18mm Laminate faced Plywood core top with a clear finish, exposed edge detail (Edge 33)
- 18mm Linoleum faced Plywood core top with a clear finish, exposed edge detail, available in a selection of colours (Edge 33)
- 12mm solid surface top available in cloud (Edge 41)
- Solid Ash legs with a clear finish
- Tubular Steel framework finished in White powder coat
- Brushed Steel tie bars
- Brushed Aluminium bag hooks (x2)
- 4 to 12 perimeter power positions (include 1x power socket, 1x twin powered USB) with accessible cable tray

### Optional Features:

- Solid Ash legs can be stained or colour washed
- Tubular Steel framework available in a selection of powder coat finishes

### Frame Finishes:



### Linoleum:



### Solid Surface Finish:

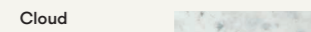

### Edge Stain:

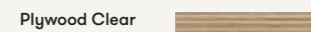

### Wood Finish:

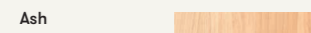

### Colour Washes based on Ash:



For larger swatches go to pg.172-183

8 Stock Laminates and 6 Wood Stains based on Ash are also available please go to pg. 177 - 181 to see more.

## High Level



SLH1809  
OW: 1800mm  
OD: 900mm



SLH2009  
OW: 2000mm  
OD: 900mm



SLH2209  
OW: 2200mm  
OD: 900mm



SLH2409  
OW: 2400mm  
OD: 900mm



SLH3409  
OW: 3400mm  
OD: 900mm

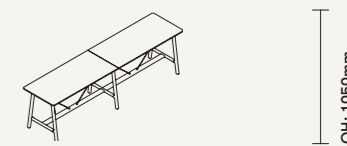

SLH3809  
OW: 3800mm  
OD: 900mm

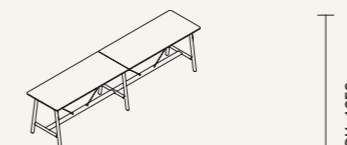

SLH4209  
OW: 4200mm  
OD: 900mm

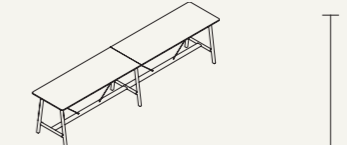

SLH4609  
OW: 4600mm  
OD: 900mm

## High Level with Power



SLHP1809 - 4 perimeter power positions  
OW: 1800mm  
OD: 900mm



SLHP2009 - 4 perimeter power positions  
OW: 2000mm  
OD: 900mm



SLHP2209 - 6 perimeter power positions  
OW: 2200mm  
OD: 900mm



SLHP2409 - 6 perimeter power positions  
OW: 2400mm  
OD: 900mm



SLHP3409 - 8 perimeter power positions  
OW: 3400mm  
OD: 900mm



SLHP3809 - 8 perimeter power positions  
OW: 3800mm  
OD: 900mm

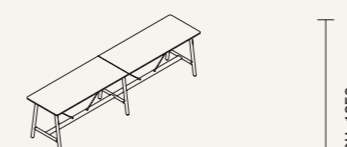

SLHP4209 - 12 perimeter power positions  
OW: 4200mm  
OD: 900mm

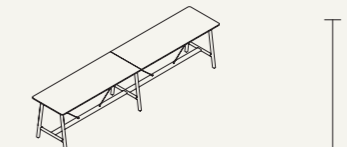

SLHP4609 - 12 perimeter power positions  
OW: 4600mm  
OD: 900mm

↓ Scan here to discover more



# Sunda 1

Design by Allermuir Design Studio

142





## Sunda 1 Low level table



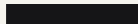

### Standard Features:

- Fabricated sheet and tubular Steel construction available in a selection of powder coat finishes
- Plastic glides

### Frame Finishes:

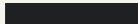
- Black (Textured) 
- White (Textured) 

### Mineral Finishes:

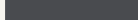
- Mineral Night 
- Mineral Forest 
- Mineral Clay 
- Mineral Sand 
- Mineral Stone 

For larger swatches go to pg.172-173

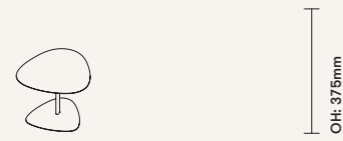

SUN101  
OW: 525mm  
OD: 510mm

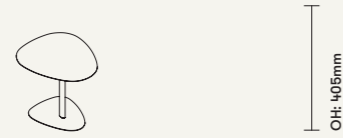

SUN102  
OW: 485mm  
OD: 425mm

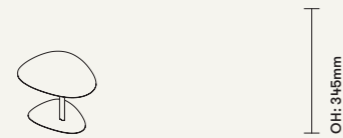

SUN103  
OW: 550mm  
OD: 460mm

↓ Scan here to discover more



↓ Scan here to discover more



# Sunda 2

Design by Allermuir Design Studio

143



## Sunda 2

### Standard Features:

- Reformed Oak veneer face tops on 25mm MDF with a cutback, clear finish edge profile
- Tubular Steel frame available in all selection of powder coat finishes
- Plastic glides



### Optional Features:

- Oak veneer tops can be stained or colour washed

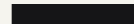
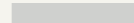
### Frame Finishes:

- Black (Textured) 
- White (Textured) 

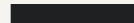
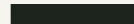
### Mineral Finishes:

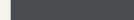
- Mineral Night 
- Mineral Forest 
- Mineral Clay 
- Mineral Sand 
- Mineral Stone 

### Veneers:

- Clear on Oak 

### Wood Stains based on Oak:

- Clear 
- White Oak 
- American Cherry 
- American Walnut 
- Dark Walnut 
- Wenge 

For larger swatches go to pg.172-177

16 optional Oak Washes are also available please go to pg. 178 to see more.

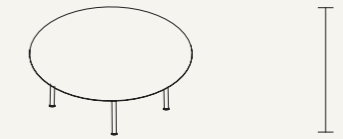

SUN201  
Dia: 1000mm

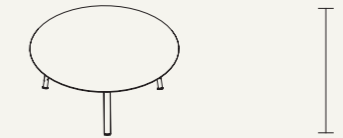

SUN202  
Dia: 800mm



SUN203  
Dia: 600mm



SUN204  
Dia: 400mm



# Tibo

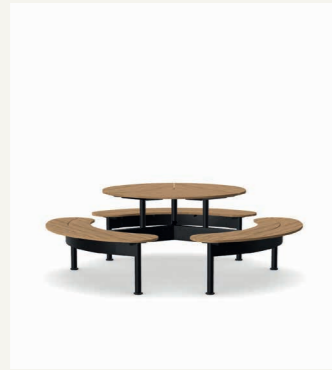

## Tibo Indoor Bench and Table



### Standard Features:

- 18mm Table top and seats in Laminate faced Ply with clear edge (Edge 33)
- 18mm Table top and seats in Laminate faced MDF with contrast edge tape in Ply, Oak, Beech, White or Black
- Cast Aluminium and extruded Aluminium frame in Black (Textured) or Ceramic White powder coat
- Colour matched stainless steel levelling feet with Nylon pad



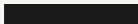

### Optional Features:

- 18mm Table top and seats in Teak (available on outdoor tables only see page 176)
- 12mm Table top and seats in Charcoal solid core laminate (available on outdoor tables only see page 176)
- Colour matched floor fixing kit

### Frame Finishes:

- Black (Textured) 
- Ceramic White 

### Edge / Edge Tape Finishes:

- Clear 
- Ply 
- Oak 
- White 
- Black 

### Solid Core Laminate:

- Charcoal 

### Solid Wood Finish:

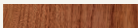
- Teak 

For larger swatches go to pg.172-183

8 optional Stock Laminates also available please go to pg. 181 to see more.

Design by Mark Gabbertas

144

145

## Round Indoor Table

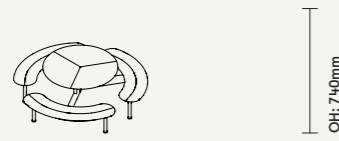

**TORDI**  
(Suitable for up to six people)

TW: 1240mm  
TD: 1240mm  
OW: 2227mm  
OD: 2227mm  
OH: 740mm  
SH: 448mm

Outdoor also available: TORD

## Large Oblong Indoor Table

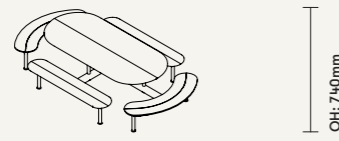

**TOLOI**  
(Suitable for up to twelve people)

TW: 2400mm  
TD: 1100mm  
OW: 3380mm  
OD: 2080mm  
OH: 740mm  
SH: 448mm

Outdoor also available: TOLO

## Mid Oblong Indoor Table

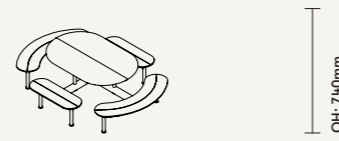

**TOMOI**  
(Suitable for up to eight people)

TW: 1662mm  
TD: 1100mm  
OW: 2642mm  
OD: 2080mm  
OH: 740mm  
SH: 448mm

Outdoor also available: TOMO

# Turo

Design by Allermuir Design Studio

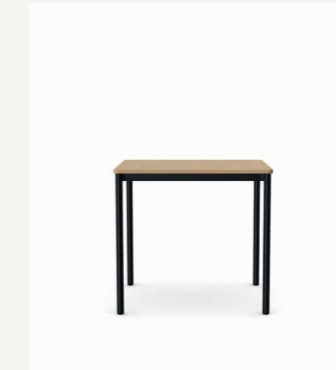

## Turo

### Standard Features:

- 18mm Laminate Plywood core top with clear finish edge (Edge 33)
- 18mm Laminate MDF core top with contrast edge tape (TE)
- Aluminium fluted legs and Steel frame under structure available in Black powder coat
- Integral leg feet with levelling adjustment





### Optional Features:

- Aluminium Fluted legs and Steel frame under structure available in a selection of powder coat finishes





### Frame Finishes:

- Black 
- White 
- Pebble 
- Sage 

### Edge Stains:

- Plywood Clear 
- Clear 
- Solid Black 
- Solid White 

### Edge Tapes:

- Ply 
- Oak 
- Beech 
- White 
- Black 

For larger swatches go to pg.172-183

8 optional Stock Laminates also available please go to pg. 181 to see more.

## Dining Circular

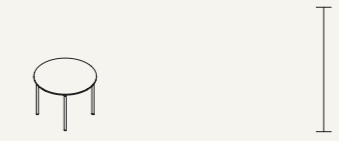

**TRT10RD**  
Dia: 1000mm



**TRT12RD**  
Dia: 1200mm

## Dining Rectangular

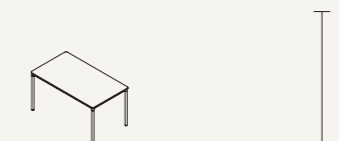

**TRT1408RC**  
OW: 1400mm  
OD: 800mm

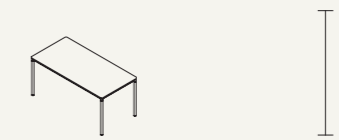

**TRT1608RC**  
OW: 1600mm  
OD: 800mm

## Dining Square

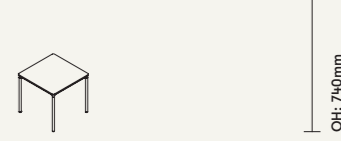

**TRT08SQ**  
OW: 800mm  
OD: 800mm



**TRT10SQ**  
OW: 1000mm  
OD: 1000mm

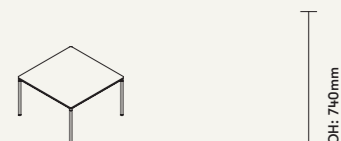

**TRT12SQ**  
OW: 1200mm  
OD: 1200mm



**TRT2009RC**  
OW: 2000mm  
OD: 900mm

↓ Scan here to discover more



↓ Scan here to discover more





## Contents

- 150 Axyl Outdoor
- 154 Crop
- 155 Tibo Outdoor

148

149

# Outdoor

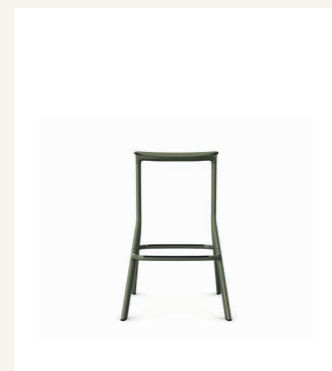
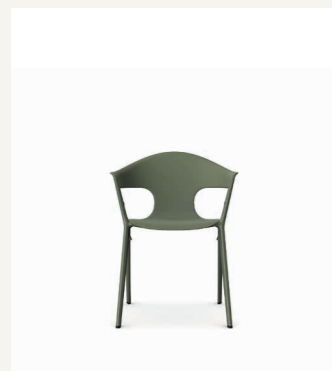

**Axyl - AXL52OD**  
Arm chair

**Dimensions:**

Seat Height	450mm
Seat Width	415mm
Seat Depth	435mm
Overall Height	780mm
Overall Width	605mm
Overall Depth	565mm



**Standard Features:**

- Plastic shell finished in Black
- Cast Aluminium frame finished in Black powder coat
- Stacking buffers
- Plastic glides
- Stacks up to 4 high

**Optional Features:**

- Plastic shell with complementary Aluminium powder coat frame available in a selection of colours

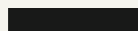
**Frame and Shell Finishes:**

Black (Textured)	
Basalt (Textured)	
Sage (Textured)	

For larger swatches go to pg.172-173

**Axyl - AXL54OD**  
High stool

**Dimensions:**

Seat Height	750mm
Seat Width	400mm
Seat Depth	385mm
Overall Height	750mm
Overall Width	495mm
Overall Depth	465mm



**Standard Features:**

- Plastic seat finished in Black
- Cast Aluminium frame finished in Black powder coat
- Integral Plastic footrest protectors
- Plastic glides

**Optional Features:**

- Plastic seat with complementary Aluminium powder coat frame available in a selection of colours

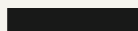
**Frame and Shell Finishes:**

Black (Textured)	
Basalt (Textured)	
Sage (Textured)	

For larger swatches go to pg.172-173



**Axyl**  
Bistro Dining Height





**Dimensions:**

Overall Height	1020mm
----------------	--------



**Standard Features:**

- 12mm table top in Solid Core Laminate
- Cast Aluminium base and Aluminium centre column finished in Black powder coat
- Integral leg feet with levelling adjustment

**Frame Finishes:**

Black (Textured)	
Basalt (Textured)	
Sage (Textured)	
Ivory	

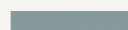
**Compact Laminate Top**

Grey	
White	
Charcoal	

For larger swatches go to pg.172-181

**Bistro Dining Height**

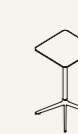

OH: 1020mm

AXLH06SQ-OD  
OW: 600mm  
OD: 600mm



OH: 1020mm

AXLH07SQ-OD  
Dia: 800mm



OH: 1020mm

AXLH08RD-OD  
OW: 750mm  
OD: 750mm

↓ Scan here to discover more



↓ Scan here to discover more



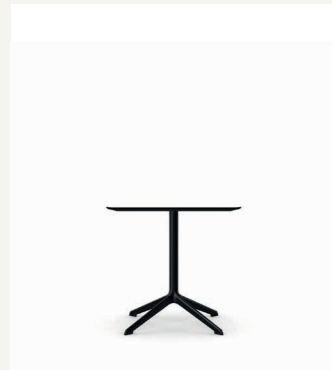

## Bistro Height

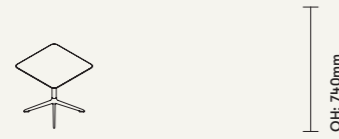

OH: 740mm

AXLD07SQ-OD  
OW: 750mm  
OD: 750mm

## Axyl Dining Height Table

Dimensions:  
Overall Height 740mm

- Standard Features:
- 12mm table top in Solid Core Laminate
  - Cast Aluminium base and Aluminium centre column finished in Matt Black powder coat
  - Integral leg feet with levelling adjustment

- Frame Finishes:
- Black (Textured)
  - Basalt (Textured)
  - Sage (Textured)
  - Ivory

- Compact Laminate Top
- Grey
  - White
  - Charcoal

For larger swatches go to pg.172-181

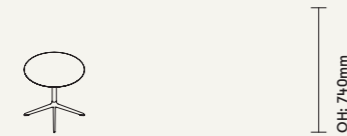

OH: 740mm

AXLH08RD-OD  
Dia: 800mm

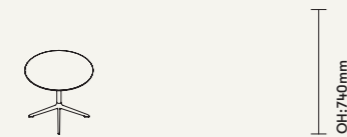

OH: 740mm

AXLD09RD-OD  
Dia: 900mm

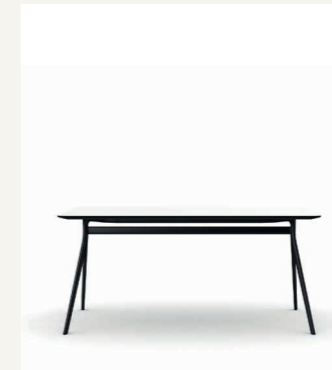

## Dining Height



OH: 740mm

AXLR1609-OD  
OW: 1600mm  
OD: 900mm

## Axyl Dining height table with rectangular top

Dimensions:  
Overall Height 740mm

- Standard Features:
- 12mm table top in Solid Core Laminate
  - Cast Aluminium base and Aluminium centre column finished in Matt Black powder coat
  - Integral leg feet with levelling adjustment

- Frame Finishes:
- Black (Textured)
  - Basalt (Textured)
  - Sage (Textured)
  - Ivory

- Compact Laminate Top
- Grey
  - White
  - Charcoal

For larger swatches go to pg.172-181

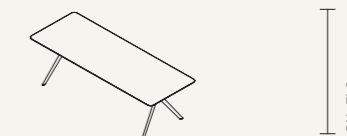

OH: 740mm

AXLR2009-OD  
OW: 2000mm  
OD: 900mm

↓ Scan here to discover more



↓ Scan here to discover more



# Crop

Design by Benjamin Hubert | Layer

154

155

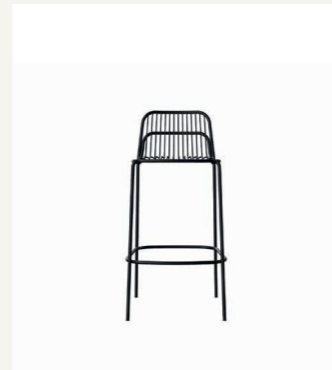
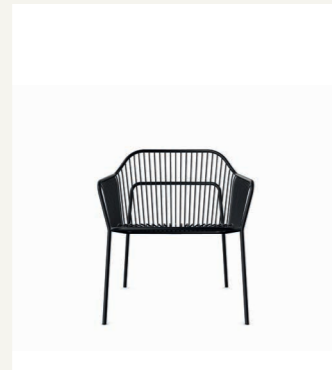

## Crop - CRP02 Armchair

Dimensions:  
 Seat Height 480mm  
 Seat Width 490mm  
 Seat Depth 435mm  
 Overall Height 835mm  
 Overall Width 620mm  
 Overall Depth 555mm

- Standard Features:
- Steel wire frame finished in Black (Textured) powder coat for outdoor use
  - Plastic stacking buffers
  - Plastic glides
  - Stacks up to 4 high

- Optional Features:
- Steel wire frame available in a selection of powder coat finishes

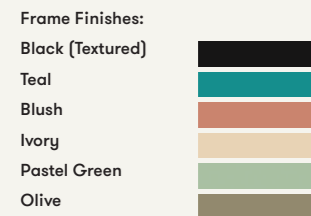

For larger swatches go to pg.172-186

## Crop - CRP03 Lounge chair

Dimensions:  
 Seat Height 420mm  
 Seat Width 510mm  
 Seat Depth 490mm  
 Overall Height 730mm  
 Overall Width 675mm  
 Overall Depth 675mm

- Standard Features:
- Steel wire frame finished in Black (Textured) powder coat for outdoor use
  - Plastic glides

- Optional Features:
- Steel wire frame available in a selection of powder coat finishes

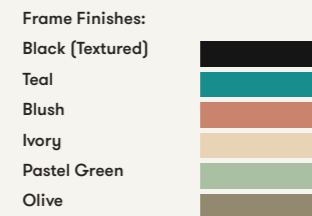

For larger swatches go to pg.172-186

## Crop - CRP05 High back stool

Dimensions:  
 Seat Height 780mm  
 Seat Width 425mm  
 Seat Depth 390mm  
 Overall Height 1015mm  
 Overall Width 475mm  
 Overall Depth 505mm

- Standard Features:
- Steel wire frame finished in Black (Textured) powder coat for outdoor use
  - Plastic glides

- Optional Features:
- Steel wire frame available in a selection of powder coat finishes
  - Counter height stool option, seat height 625mm (add CH to product code)

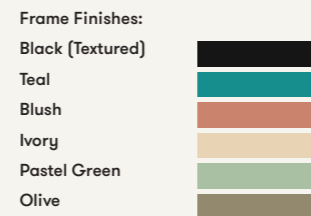

For larger swatches go to pg.172-186



# Tibo Outdoor

Design by Allermuir Design Studio

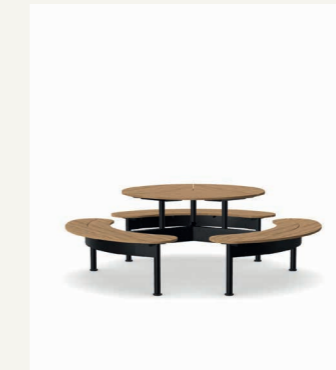

## Tibo

- Standard Features:
- 18mm Table top and seats in Teak
  - 18mm Table top and seats in charcoal solid core laminate
  - Cast aluminium and extruded aluminium frame in Black (Textured) or Ceramic White powder coat
  - Colour matched stainless steel levelling feet with Nylon pad
  - Colour matched floor fixing kit

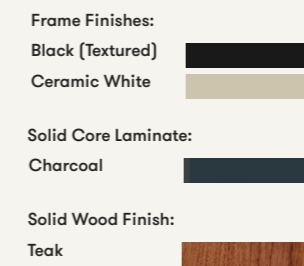

For larger swatches go to pg.172-185

## Round Oblong Outdoor Table



TORD  
 (Suitable for up to six people)

TW: 1240mm  
 TD: 1240mm  
 OW: 2227mm  
 OD: 2227mm  
 OH: 740mm  
 SH: 448mm

## Mid Oblong Outdoor Table

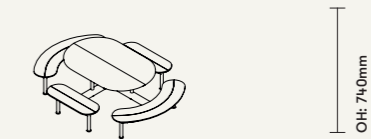

TOMO  
 (Suitable for up to eight people)

TW: 1662mm  
 TD: 1100mm  
 OW: 2642mm  
 OD: 2080mm  
 OH: 740mm  
 SH: 448mm

## Large Oblong Outdoor Table

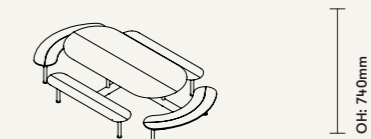

TOLO  
 (Suitable for up to twelve people)

TW: 2400mm  
 TD: 1100mm  
 OW: 3380mm  
 OD: 2080mm  
 OH: 740mm  
 SH: 448mm

↓ Scan here to discover more



↓ Scan here to discover more



## Contents

- 158 Crate Divide
- 166 Crate
- 167 Crate Caddy
- 168 Furow
- 169 Mozaik Storage

156

157

# Storage

# Crate Divide

Design by Allermuir Design Studio

158

159

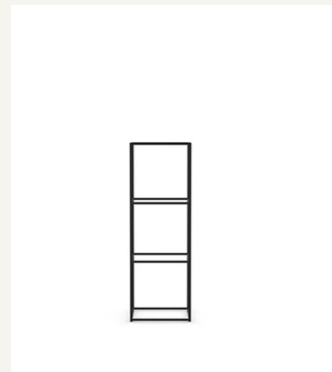

## Crate Divide





### Standard Features:

- Tubular Steel frame finished in Black powder coat
- Plastic glides with levelling adjustment

### Optional Features:

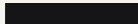
- Tubular Steel frame available in a selection of colours

### Finishes:



- Black (Standard) 
- White 
- Sage 
- Bronze 

For larger swatches go to pg.172-173

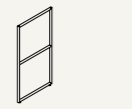
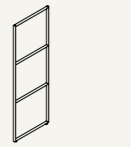
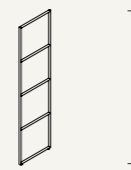
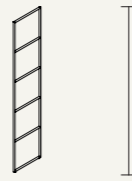

## Floor Standing Inline Steel End Ladders

			
OH: 900mm	OH: 1342mm	OH: 1784mm	OH: 2226mm
<b>CRT2HE</b> OW: 458mm OD: 16mm	<b>CRT3HE</b> OW: 458mm OD: 16mm	<b>CRT4HE</b> OW: 458mm OD: 16mm	<b>CRT5HE</b> OW: 458mm OD: 16mm
2 High End Ladder with tapped holes on one face	3 High End Ladder with tapped holes on one face	4 High End Ladder with tapped holes on one face	5 High End Ladder with tapped holes on one face

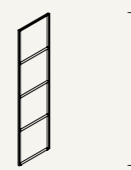
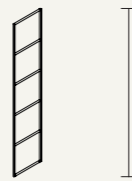
## Floor Standing Inline Steel Mid Ladders

			
OH: 900mm	OH: 1342mm	OH: 1784mm	OH: 2226mm
<b>CRT2HM</b> OW: 458mm OD: 16mm	<b>CRT3HM</b> OW: 458mm OD: 16mm	<b>CRT4HM</b> OW: 458mm OD: 16mm	<b>CRT5HM</b> OW: 458mm OD: 16mm
2 High Mid Ladder with tapped holes on both front and back faces	3 High Mid Ladder with tapped holes on both front and back faces	4 High Mid Ladder with tapped holes on both front and back faces	5 High Mid Ladder with tapped holes on both front and back faces

## Floor Standing L-Corner End Frames

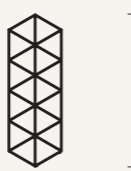
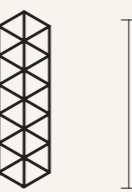
			
OH: 900mm	OH: 1342mm	OH: 1784mm	OH: 2226mm
<b>CRT2H90-KD</b> OW: 458mm OD: 458mm	<b>CRT3H90-KD</b> OW: 458mm OD: 458mm	<b>CRT4H90-KD</b> OW: 458mm OD: 458mm	<b>CRT5H90-KD</b> OW: 458mm OD: 458mm
2 High L-Corner End Frame	3 High L-Corner End Frame	4 High L-Corner End Frame	5 High L-Corner End Frame
Welded corner frame with tapped holes on two sides	Welded corner frame with tapped holes on two sides	Welded corner frame with tapped holes on two sides	Welded corner frame with tapped holes on two sides

## Floor Standing T-Corner End Frames

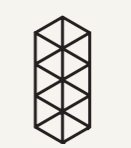
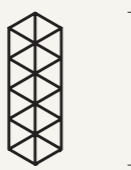
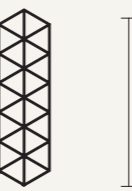
			
OH: 900mm	OH: 1342mm	OH: 1784mm	OH: 2226mm
<b>CRT2H180-KD</b> OW: 458mm OD: 458mm	<b>CRT3H180-KD</b> OW: 458mm OD: 458mm	<b>CRT4H180-KD</b> OW: 458mm OD: 458mm	<b>CRT5H180-KD</b> OW: 458mm OD: 458mm
2 High T-Corner End Frame	3 High T-Corner End Frame	4 High T-Corner End Frame	5 High T-Corner End Frame
Welded corner frame with tapped holes on three sides	Welded corner frame with tapped holes on three sides	Welded corner frame with tapped holes on three sides	Welded corner frame with tapped holes on three sides

↓ Scan here to discover more



↓ Scan here to discover more



# Crate Divide

Design by Allermuir Design Studio

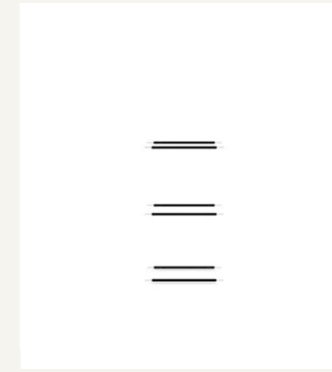

## Crate Divide





### Standard Features:

- Tubular Steel frame finished in Black powder coat
- Floor and wall fixing brackets (Single connector bar packs only)

### Optional Features:

- Tubular Steel frame available in a selection of colours

### Finishes:

- Black (Standard) 
- White 
- Sage 
- Bronze 

For larger swatches go to pg.172-173

## Connector Bar Packs



**CRT6CB-KD - Single Fixing Kit**

- 6x Connector bars
- 12x Connector Castings
- 12x M5x10 CSK bolts
- 12x M4x10 CAP bolts
- 1 Wall Bracket, 4 Spacers
- 2 Floor Hooks

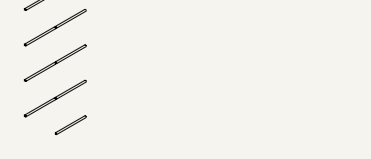

**CRT8CB-KD - Single Fixing Kit**

- 8x Connector bars
- 16x Connector Castings
- 16x M5x10 CSK bolts
- 16x M4x10 CAP bolts
- 1 Wall Bracket, 4 Spacers
- 2 Floor Hooks



**CRT10CB-KD - Single Fixing Kit**

- 10x Connector bars
- 20x Connector Castings
- 20x M5x10 CSK bolts
- 20x M4x10 CAP bolts
- 1 Wall Bracket, 4 Spacers
- 2 Floor Hooks



**CRT12CB-KD - Single Fixing Kit**

- 12x Connector bars
- 24x Connector Castings
- 24x M5x10 CSK bolts
- 24x M4x10 CAP bolts
- 1 Wall Bracket, 4 Spacers
- 2 Floor Hooks

## Double Connector Bar Packs



**CRT2DCB-KD**

- 2x Double connector bars
- 4x Connector Castings
- 4x M5x10 CSK bolts
- 4x M4x10 CAP bolts

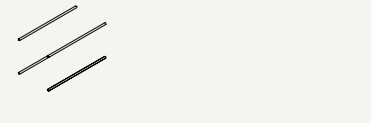

**CRT4DCB-KD**

- 4x Double connector bars
- 8x Connector Castings
- 8x M5x10 CSK bolts
- 8x M4x10 CAP bolts

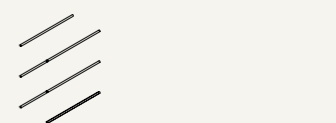

**CRT6DCB-KD**

- 6x Double connector bars
- 12x Connector Castings
- 12x M5x10 CSK bolts
- 12x M4x10 CAP bolts



# Crate Divide

Design by Allermuir Design Studio

160

161



## Bay Storage

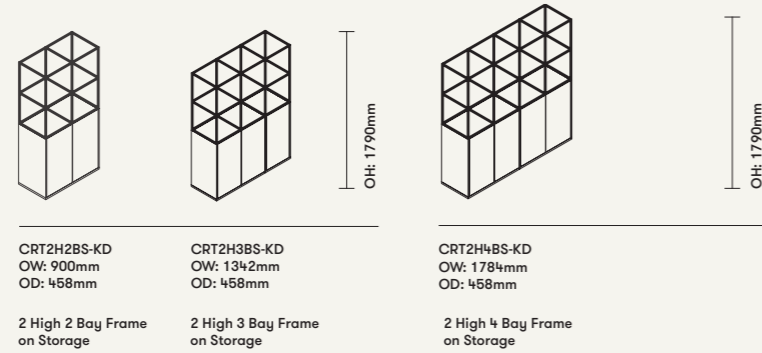

## Crate Divide

### Standard Features:

- Tubular Steel frame finished in Black powder coat
- MFC Storage available in Black, White, Strata Oak or Urban Maple
- MFC Cubby available in complementary Black, White, Strata Oak or Urban Maple
- Plastic glides with levelling adjustment

### Optional Features:

- Tubular Steel frame available in a selection of colours
- Storage and accessories available on pg.164

### Finishes:

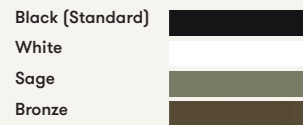

### MFC Finishes:

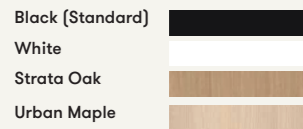

For larger swatches go to pg.172-182

## Cubby Storage

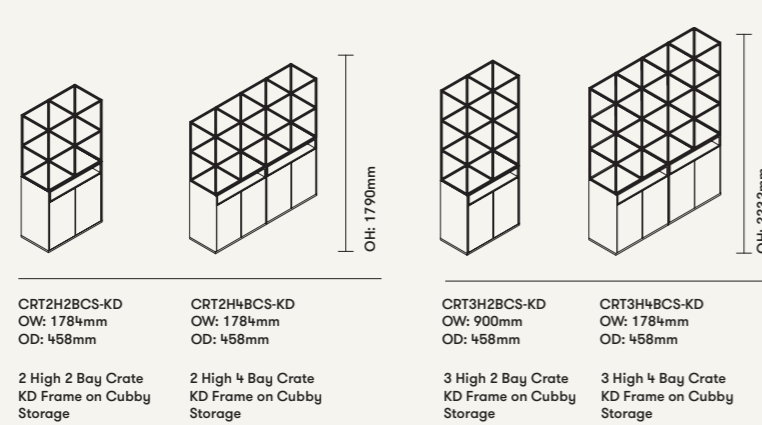

# Crate Divide

Design by Allermuir Design Studio

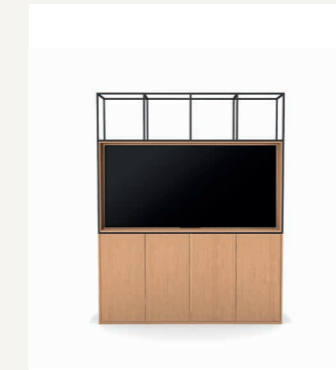

## Media Unit

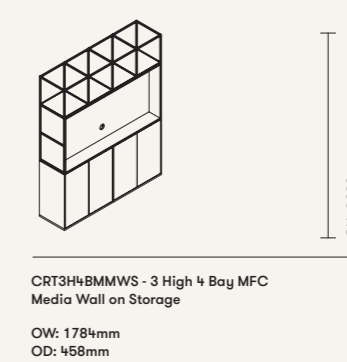

## Crate Divide Media Wall on Storage

### Standard Features:

- Tubular Steel frame finished in Black powder coat
- MFC Lower Storage available in Black, White, Strata Oak or Urban Maple
- MFC Media Wall Box available in Black, White, Strata Oak or Urban Maple
- Ply Media Wall Box available in Ply with a clear lacquered finish [CRT3H4BPMWS]
- Plastic glides with levelling adjustment
- Pinnable fabric back panel available in Camira Blazer or Synergy

### Optional Features:

- Tubular Steel frame available in a selection of colours

### Finishes:

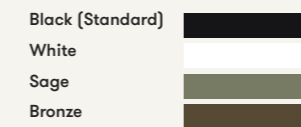

### MFC Finishes:

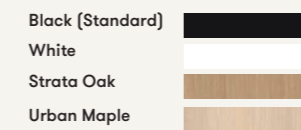

### Ply Finish:

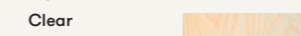

For larger swatches go to pg.172-182

↓ Scan here to discover more



↓ Scan here to discover more



# Crate Divide

Design by Allermuir Design Studio

162

163



Crate Divide - CRT2H2BMS-KD  
2 High 2 Bay on Mobile Storage

Dimensions:  
Overall Height 1880mm  
Overall Width 900mm  
Overall Depth 458mm

- Standard Features:
- Tubular Steel frame finished in Black powder coat
  - MFC Storage available in Black, White, Strata Oak or Urban Maple
  - Metal casters with wheel brakes

- Optional Features:
- Tubular Steel frame available in a selection of colours
  - Storage and accessories available on pg.164

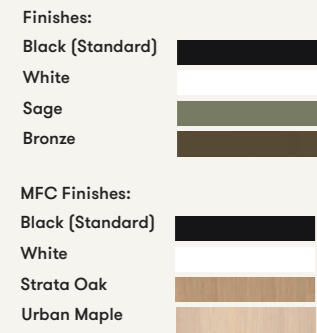

For larger swatches go to pg.172-182

Crate Divide - CRT2H3BMS-KD  
2 High 3 Bay on Mobile Storage

Dimensions:  
Overall Height 1880mm  
Overall Width 1342mm  
Overall Depth 458mm

- Standard Features:
- Tubular Steel frame finished in Black powder coat
  - MFC Storage available in Black, White, Strata Oak or Urban Maple
  - Metal casters with wheel brakes

- Optional Features:
- Tubular Steel frame available in a selection of colours
  - Storage and accessories available on pg.164

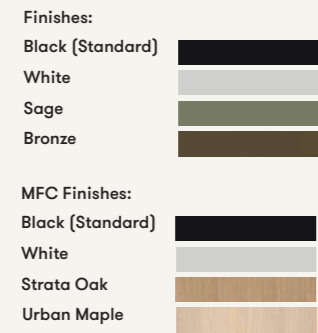

For larger swatches go to pg.172-182

Crate Divide - CRT2H4BMS-KD  
2 High 4 Bay on Mobile Storage

Dimensions:  
Overall Height 1880mm  
Overall Width 1784mm  
Overall Depth 458mm

- Standard Features:
- Tubular Steel frame finished in Black powder coat
  - MFC Storage available in Black, White, Strata Oak or Urban Maple
  - Metal casters with wheel brakes

- Optional Features:
- Tubular Steel frame available in a selection of colours
  - Storage and accessories available on pg.164

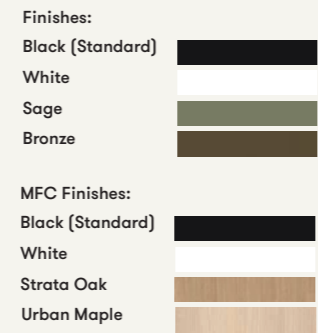

For larger swatches go to pg.172-182

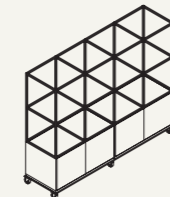
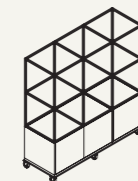

↓ Scan here to discover more



↓ Scan here to discover more



# Crate Divide

Design by Allermuir Design Studio

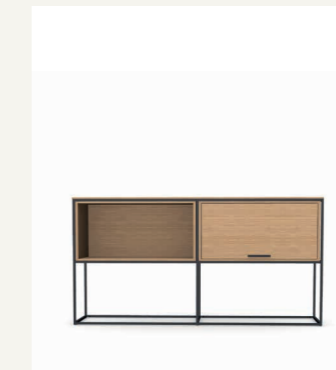

Crate Divide Credenza

- Standard Features:
- Tubular Steel frame finished in Black powder coat
  - MFC storage available in Black, White, Strata Oak or Urban Maple
  - Ply Storage available in clear lacquer finish
  - 12mm Solid surface top available in Cloud

- Optional Features:
- Tubular Steel frame available in a selection of powder coat finishes

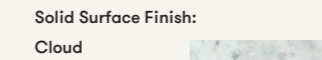
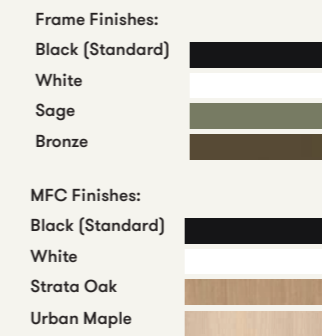

For larger swatches go to pg.172-182

## Low Credenza

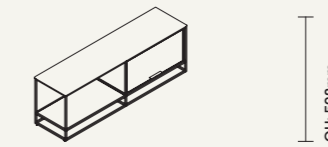

CRTLCDMSFD  
OW: 1788mm  
OD: 458mm

Low Credenza with MFC Shelf and Flipper Door storage unit. Also available in Ply: CRTLCDPSFD

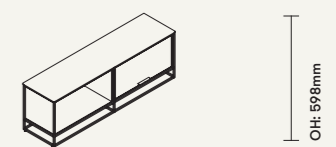

CRTLCDMCBFD  
OW: 1788mm  
OD: 458mm

Low Credenza with MFC Closed Box and Flipper Door storage unit. Also available in Ply: CRTLCDPCBFD

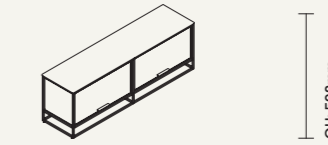

CRTLCDM2FD  
OW: 1788mm  
OD: 458mm

Low Credenza with 2 MFC Flipper Door Storage units. Also available in Ply: CRTLCDP2FD

## High Credenza

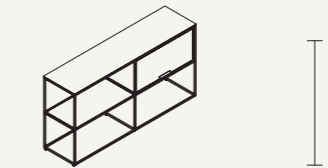

CRTHCDMSFD  
OW: 1788mm  
OD: 458mm

High Credenza with MFC Shelf and Flipper Door storage unit. Also available in Ply: CRTHCDPSFD

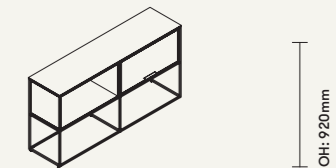

CRTHCDMCBFD  
OW: 1788mm  
OD: 458mm

High Credenza with MFC Closed Box and Flipper Door storage unit. Also available in Ply: CRTHCDPCBFD

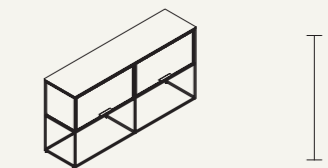

CRTHCDM2FD  
OW: 1788mm  
OD: 458mm

High Credenza with 2 MFC Flipper Door Storage units. Also available in Ply: CRTHCDP2FD

# Crate Divide

Design by Allermuir Design Studio

164

165

## Storage & Accessories

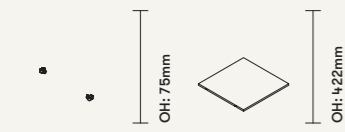

**CRTLK - 2 Linking Brackets**  
OW: 19mm  
OD: 17.5mm

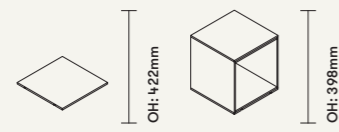

**CRTPS - Ply shelf**  
OW: 422mm  
OD: 12mm

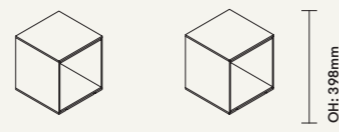

**CRTMOB - MFC open box**  
OW: 398mm  
OD: 422mm

**CRTPCB - Ply closed box**  
OW: 398mm  
OD: 410mm

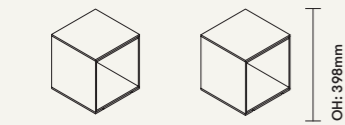

**CRTMCB - MFC closed box**  
OW: 398mm  
OD: 410mm

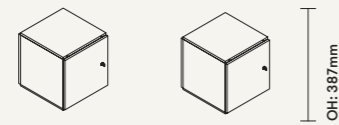

**CRTPLB - Ply Locker**  
OW: 387mm  
OD: 420mm

**CRTMLB - MFC Locker**  
OW: 387mm  
OD: 420mm

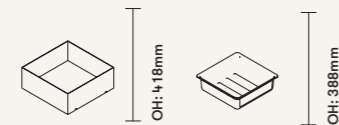

**CRTSPT - Steel planter tray**  
OW: 418mm  
OD: 132mm

**CRTPPT - Plastic planter tray**  
OW: 388mm  
OD: 127mm

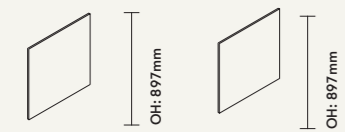

**CRTMP - Magnetic dry wipe back panel**  
OW: 884mm

**CRTFPF - Pinnable fabric back panel**  
OW: 884mm

Available in Camira Blazer or Synergy Fabric Finish

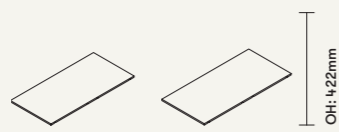

**CRT2BPS - 2 Bay Ply Shelf**  
OW: 864mm  
OD: 12mm

**CRT2BMS - 2 Bay MFC Shelf**  
OW: 864mm  
OD: 12mm

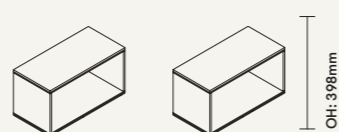

**CRT2BPOB - 2 Bay Ply Open Box**  
OW: 840mm  
OD: 422mm

**CRT2BMOB - 2 Bay MFC Open Box**  
OW: 840mm  
OD: 422mm

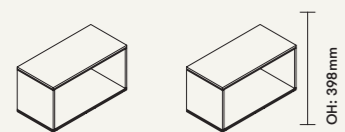

**CCRT2BPCB - 2 Bay Ply Closed Box**  
OW: 840mm  
OD: 410mm

**CRT2BMCB - 2 Bay MFC Closed Box**  
OW: 840mm  
OD: 410mm

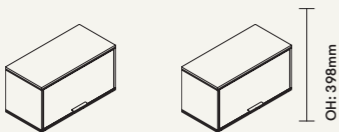

**CRT2BPFDB - 2 Bay Ply Box with Flipper Door**  
OW: 840mm  
OD: 392mm

**CRT2BMFDB - 2 Bay MFC Box with Flipper Door**  
OW: 840mm  
OD: 392mm

↓ Scan here to discover more



↓ Scan here to discover more



Crate Divide - Configurations:  
Create your own using our product configurator at [allermuir.com](http://allermuir.com)

Example 1

- 2x CRT5HE
- 1x CRT3HM
- 2x CRT8CB-KD
- 1x CRT4DCB-KD

Left Facing

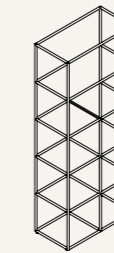

Forward Facing

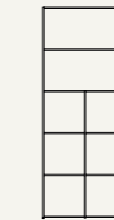

Example 2

- 1x CRT5HE
- 1x CRT3HE
- 1x CRT3HM
- 1x CRT5HM
- 2x CRT2HM
- 1x CRT4HM
- 4x CRT12CB-KD
- 2x CRT4DCB-KD
- 1x CRT2DCB-KD
- 1x CRT5H90-KD

Left Facing

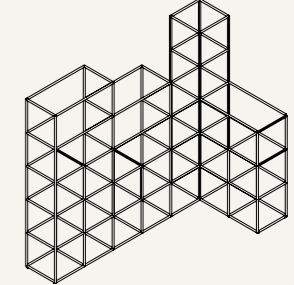

Forward Facing

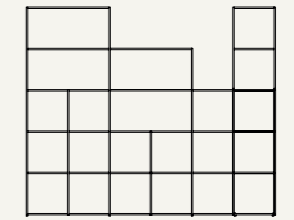

Example 3

- 1x CRT3H4BMMWS
- 4x CRT5HE
- 2x CRT5HM
- 4x CRT12CB-KD

(Optional linking kits)  
2x CRTLK

Left Facing

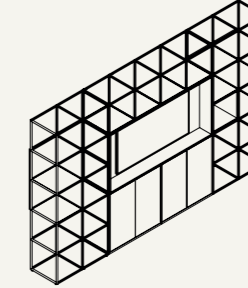

Forward Facing

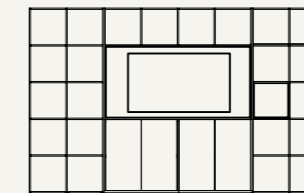

Example 4

- 1x CRT3H4BMMWS
- 2x CRT3H2BS-KD

(Optional linking kits)  
2x CRTLK

Left Facing

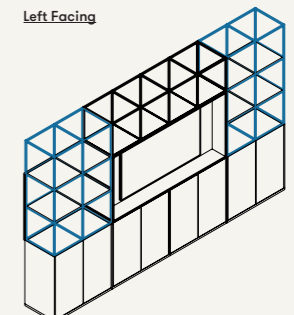

Forward Facing

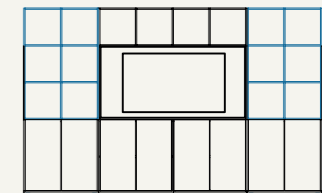

Example 5

- 1x CRT3HE
- 1x CRT5HE
- 1x CRT5H90-KD
- 5x CRT2HM
- 1x CRT3HM
- 3x CRT4HM
- 3x CRT5HM
- 7x CRT12CB-KD
- 1x CRT8CB-KD
- 4x CRT6DCB-KD

Left Facing

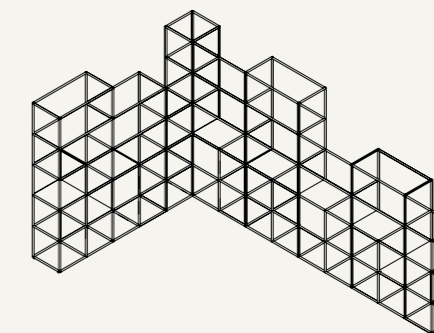

Front Facing

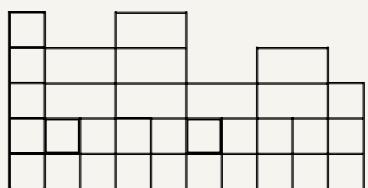

# Crate

Design by Allermuir Design Studio

166



## Crate — CRT6020 Planter

### Dimensions:

Overall Height 630mm  
Overall Width 600mm  
Overall Depth 250mm

### Standard Features:

- Steel frame and box insert finished in Black powder coat
- Solid Oak top shelf with a clear finish
- Plastic glides

### Optional Features:

- Steel frame and box insert available in Sage or Pebble powder coat

### Finishes:

Black 

Pebble 

Sage 

### Solid Wood Finish:

Clear on Oak 

For larger swatches go to pg.172-176



# Crate Caddy

Design by Allermuir Design Studio

167

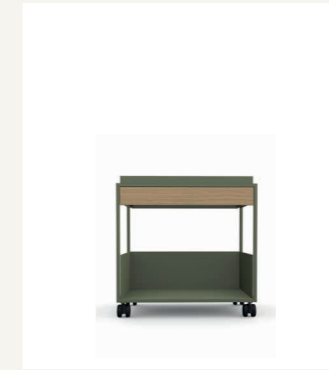

## Crate Caddy — CRTCDY Mobile caddy storage unit

### Dimensions:

Overall Height 560mm  
Overall Width 350mm  
Overall Depth 330mm

### Standard Features:

- Tubular Steel frame finished in Black powder coat
- Cork lining on top tray and shelf
- Oak-fronted shelf on steel runners
- Plastic casters

### Optional Features:

- Tubular Steel frame available in a selection of colours.

### Finishes:

Black 

White 

Sage 

Bronze 

For larger swatches go to pg.172-173



↓ Scan here to  
discover more



↓ Scan here to  
discover more



# Furow

Design by Allermuir Design Studio

168

169

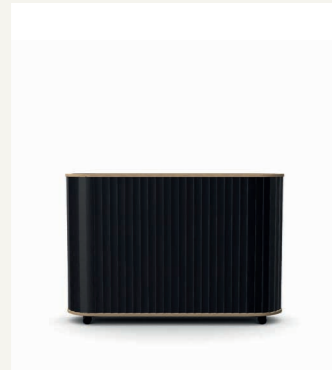

## Steel Planter

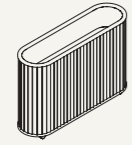

OH: 950mm

FW4014S  
OW: 1400mm  
OD: 400mm

## Timber Planter



OH: 950mm

FW4014T  
OW: 1400mm  
OD: 400mm

## Furow

### Standard Features:

- Steel frame finished in Black or White powder coat
- Oak frame with a clear finish on Timber Planter
- Ply panels on Steel Planter with a clear finish
- Matt Black HIPS liner
- Casters with wheel brake

### Steel Frame Finishes:

Black   
White 

### Oak Frame Finish:

Clear 

For larger swatches go to pg.124-126



OH: 400mm

FW40RDS  
Dia: 400mm



OH: 400mm

FW40RDT  
Dia: 400mm

# Mozaik Storage

Design by Allermuir Design Studio

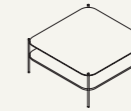

OH: 395mm

MZKLT  
OW: 860mm  
OD: 860mm

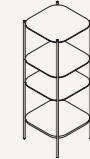

OH: 1175mm

MZKHSS  
OW: 430mm  
OD: 430mm

## Mozaik Storage



### Standard Features:

- Laminate faced MDF core surface available in Matt White or Black
- Edge profile is stained to match the laminate top
- Wire frame finished in Black powder coat
- Plastic glides

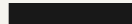

### Optional Features:

- Wire frame available in White powder coat

### Frame Finishes:

Black   
White 

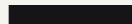
### Laminate face MFC core surface:

Matt Black   
Matt White 

For larger swatches go to pg.172-182



H: 595mm

MZKLS  
OW: 430mm  
OD: 430mm



OH: 595mm

MZKLS  
OW: 860mm  
OD: 430mm

↓ Scan here to discover more



↓ Scan here to discover more



## Contents

172	Metal / Frame Finishes
174	Plastic / Shell Finishes
174	PU Shell Finishes
175	Solid Surfaces and Marble / Stone Finishes
175	Linoleum
175	Special Finishes - Batan Collection
176	Solid Wood and Veneer Finishes
177	Wood Stains
178	Colour Washes
180	Global and Matte Laminates
181	Stock Laminates
181	Solid Core Laminates
182	MFC
182	Kvadrat Really Tops
183	Edge Stains and Edge Tapes
184	Edge Details
185	Outdoor Finishes
186	Seat Pad Upholstery
187	Loose Cushion Details
188	Tylus Finishes

\* Care has been taken to show all finishes as true as possible however colours shown may vary slightly from the actual product. Finish samples and cards showing actual colour and finish are available on request, please speak to your sales representative.

# Metal / Frame Finishes



**Aubergine** Matt Finish  
**Basalt** Matt Finish  
**Basalt (Textured)** FineTex Finish  
**Black** Standard Finish  
**Black (Textured)** FineTex Finish  
**Blue Skies** FineTex Finish



**Blush** FineTex Finish  
**Brass Plated** Metal Finish  
**Bronze** Standard Finish  
**Brushed Chrome** Metal Finish  
**Ceramic white** FineTex Finish  
**Coral** Matt Finish



**Crayon Grey** Matt Finish  
**Dark Bronze** Standard Finish  
**Deep Mulberry** FineTex Finish  
**Forest Green (Textured)** FineTex Finish  
**Haze Blue** Matt Finish  
**Ivory** FineTex Finish



**Matt Black** Matt Finish  
**Matt White** Matt Finish  
**Mellow Yellow** FineTex Finish  
**Mineral Clay** Mineralized Finish  
**Mineral Forest** Mineralized Finish  
**Mineral Night** Mineralized Finish



**Mineral Sand** Mineralized Finish  
**Mineral Stone** Mineralized Finish  
**New Black** Standard Finish  
**Off Black** Matt Finish  
**Olive** FineTex Finish  
**Orange Crush** FineTex Finish

# Metal / Frame Finishes



**Pastel Green** FineTex Finish  
**Peacock Blue** Matt Finish  
**Pebble** Matt Finish  
**Pistachio** Matt Finish  
**Polished Aluminium** Metal Finish  
**Polished Chrome** Metal Finish



**Red** Matt Finish  
**Sage** Matt Finish  
**Sage (Textured)** FineTex Finish  
**Seattle Green** Matt Finish  
**Silver MO4** Standard Finish  
**Slate Grey** Standard Finish



**Soft Gold** FineTex Finish  
**Soft Silver** FineTex Finish  
**Stone** Matt Finish  
**Teal** FineTex Finish  
**Touch of Grey** FineTex Finish  
**Ultramarine Blue** FineTex Finish

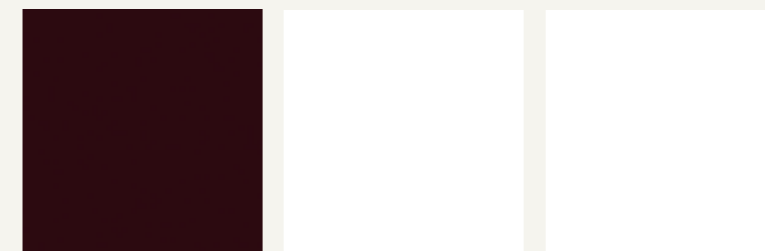

**Vintage Red** FineTex Finish  
**White** Standard Finish  
**White (Textured)** FineTex Finish

# Plastic / Shell Finishes



**Aubergine**  
Plastic / Shell Finish

**Basalt**  
Plastic / Shell Finish

**Black / Back to Black**  
Plastic / Shell Finish

**Blue Skies**  
Plastic / Shell Finish

**Coral**  
Plastic / Shell Finish

**Crayon Grey**  
Plastic / Shell Finish

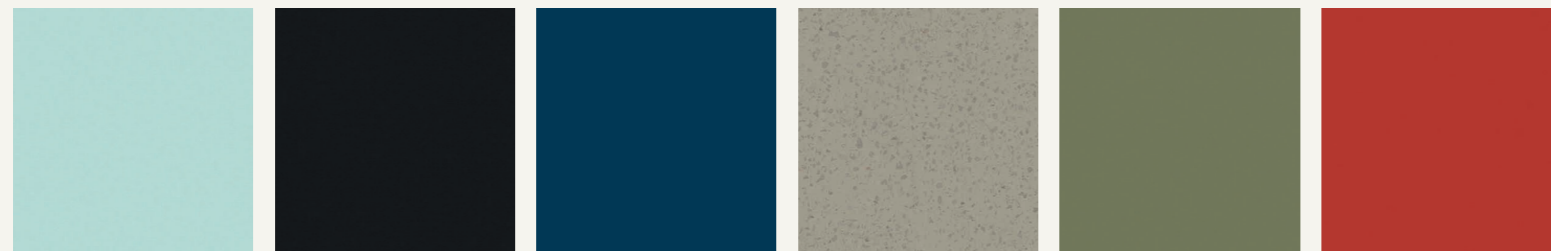

**Haze Blue**  
Plastic / Shell Finish

**Off Black**  
Plastic / Shell Finish

**Peacock Blue**  
Plastic / Shell Finish

**Pebble - Wood Fibre**  
Plastic / Shell Finish

**Pistachio**  
Plastic / Shell Finish

**Red**  
Plastic / Shell Finish

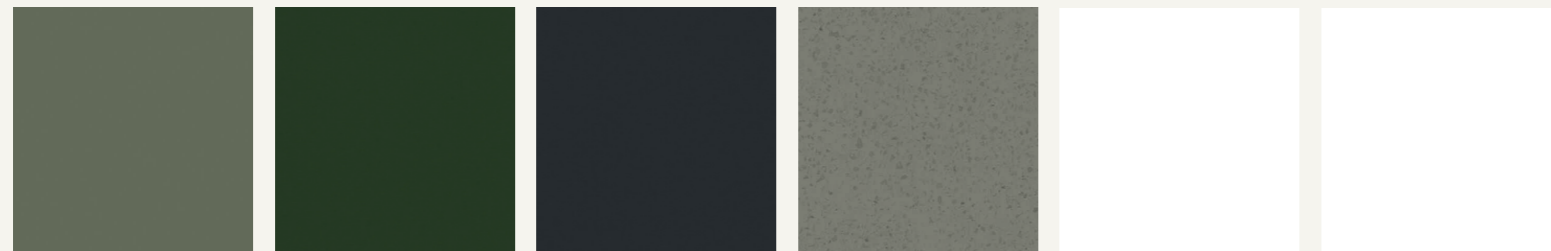

**Sage**  
Plastic / Shell Finish

**Seattle Green**  
Plastic / Shell Finish

**Slate Grey**  
Plastic / Shell Finish

**Stone - Wood Fibre**  
Plastic / Shell Finish

**White**  
Plastic / Shell Finish

**White as Snow**  
Plastic / Shell Finish

# PU Shell Finishes

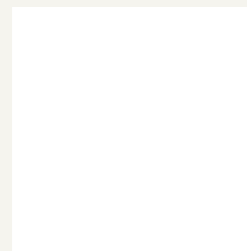

**Pure White**  
PU

# Solid Surfaces / Marble / Stone Finishes

\* Finishes are not to scale for a representation please order a finish card.

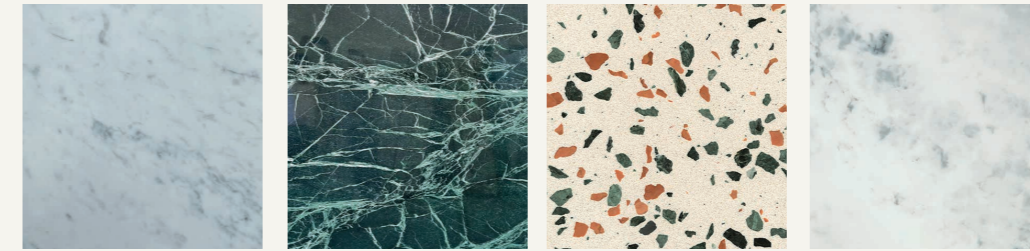

**White Marble**  
Carrara  
Solid Marble Finish

**Green Marble**  
Verde Oriental  
Solid Marble Finish

**Terrazzo**  
Vendome  
Solid Stone Finish

**Cloud**  
Solid Surface

# Linoleum

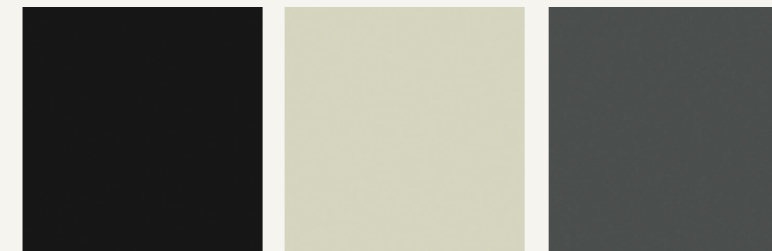

**Charcoal**  
Linoleum

**Mushroom**  
Linoleum

**Pewter**  
Linoleum

# Special Finishes

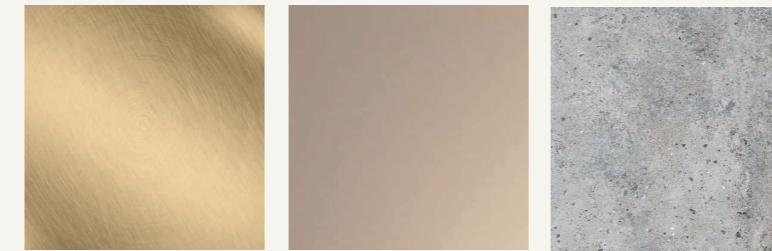

**Brass Plated**  
Top Finish

**Frosted Beige Glass**  
Top Finish

**Natural**  
Concrete Base Finish



# Solid Wood Finishes

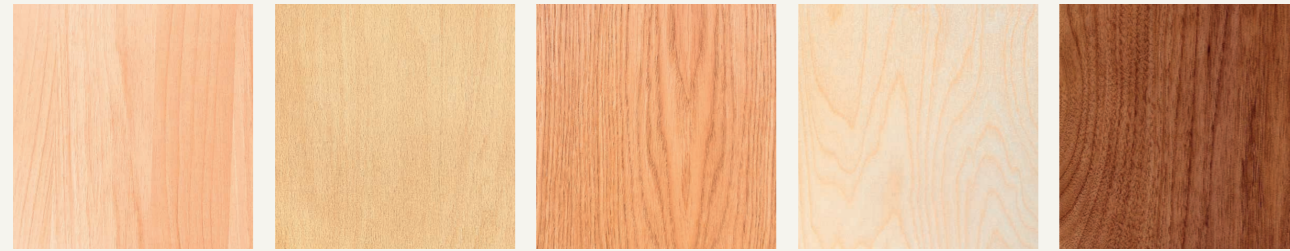

Ash with Clear Finish Wood Finishes  
Beech with Clear Finish Wood Finishes  
Oak with Clear Finish Wood Finishes  
Ply with Clear Finish Wood Finishes  
Teak Wood Finishes

# Solid Oak Top Finishes



Oak with Clear Finish Solid Oak Top Finish  
Black Oak Top Solid Oak Stain  
Blue Oak Top Solid Oak Stain

# Veneers

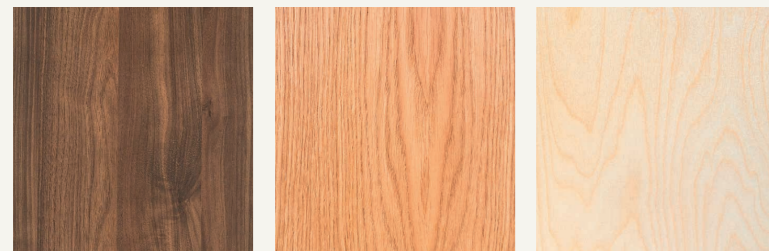

Clear Walnut Veneer  
Clear Oak Veneer  
Plywood Veneer Frame / Shell Finish

# Wood Stains Based on Ash



Clear Based on Ash  
White Oak Based on Ash  
American Cherry Based on Ash  
American Walnut Based on Ash  
Dark Walnut Based on Ash  
Wenge Based on Ash

# Wood Stains Based on Beech



Clear Based on Beech  
White Oak Based on Beech  
American Cherry Based on Beech  
American Walnut Based on Beech  
Dark Walnut Based on Beech  
Wenge Based on Beech

# Wood Stains Based on Oak



Clear Based on Oak  
White Oak Based on Oak  
American Cherry Based on Oak  
American Walnut Based on Oak  
Dark Walnut Based on Oak  
Wenge Based on Oak

# Standard Colour Washes



\* Colours may vary depending on Solid Wood type (Ash, Beech or Oak)  
For a representation of colour washes on specific wood finish types, please order a finish card.

# Axyl Bench Colour Washes

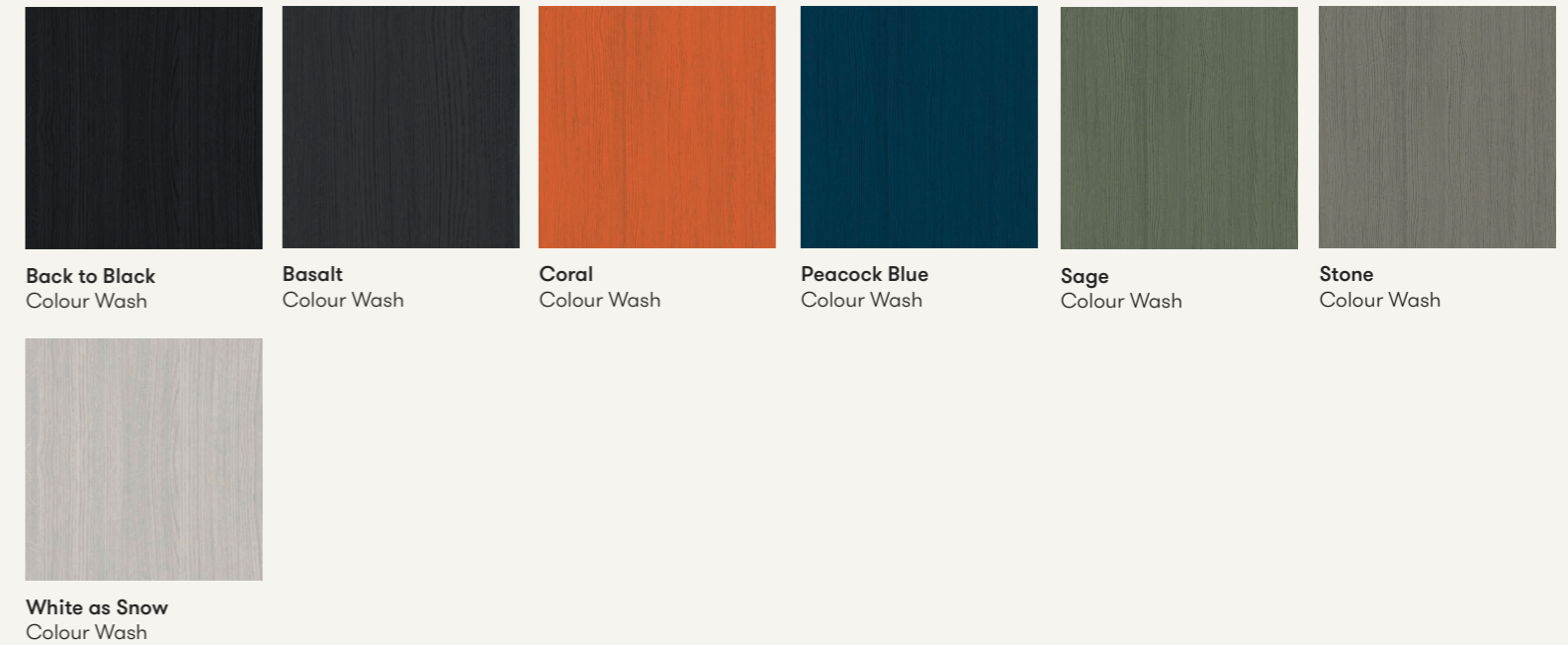

# Folk / Kin Colour Washes

\* Haze Blue and Red colour washes apply to Kin only.



# Global Laminates



**Brite White**  
Global Laminate

**Fog**  
Global Laminate

**Mouse**  
Global Laminate

**Fossil**  
Global Laminate

**Storm**  
Global Laminate

**Sarum Grey**  
Global Laminate

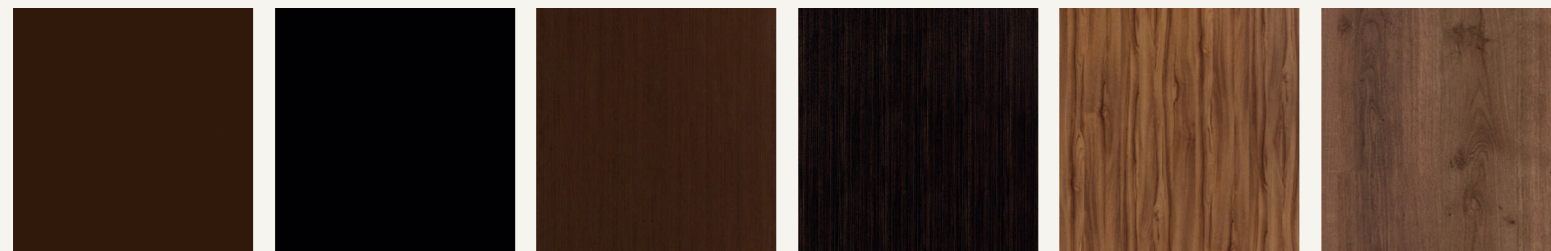

**Dark Chocolate**  
Global Laminate

**Diamond Black**  
Global Laminate

**Chestnut Woodline**  
Global Laminate

**Ebony**  
Global Laminate

**Oiled Walnut**  
Global Laminate

**Planked Coffee Oak**  
Global Laminate



**Smoky Brown Pear**  
Global Laminate

**Millennium Oak**  
Global Laminate

**Natural Ash**  
Global Laminate

**White Ash**  
Global Laminate

# Matt Laminates

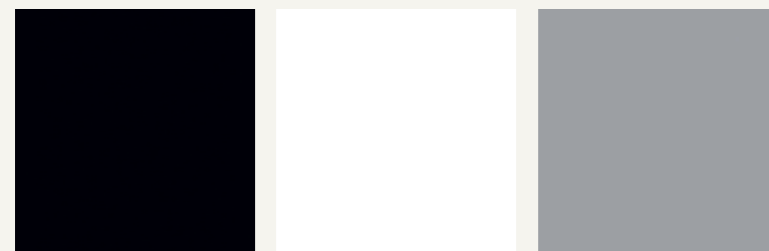

**Matt Black**  
Matt Laminate

**Matt White**  
Matt Laminate

**Tusk Grey**  
Matt Laminate

# Stock Laminates

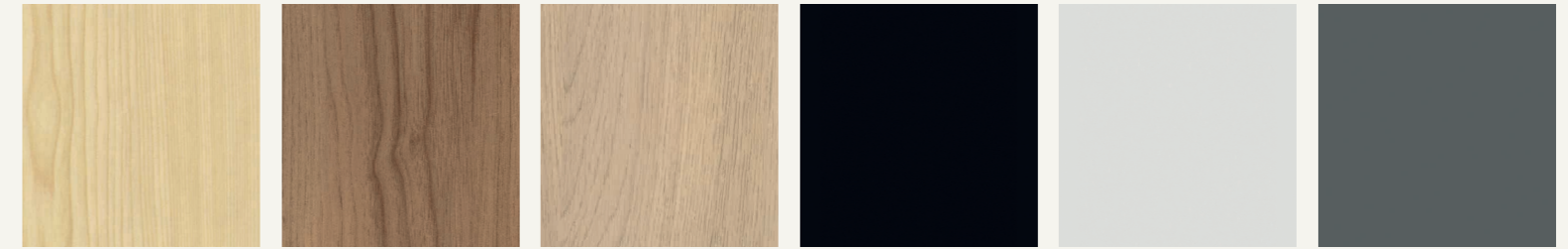

**Ash**  
Stock Laminate

**Biella Walnut**  
Stock Laminate

**Summer Oak**  
Stock Laminate

**Jet Black**  
Stock Laminate

**Light Grey**  
Stock Laminate

**Pewter Grey**  
Stock Laminate



**Platinum**  
Stock Laminate

**White**  
Stock Laminate

# Solid Core Laminates

\* Core of all Solid Core Laminates is Black.

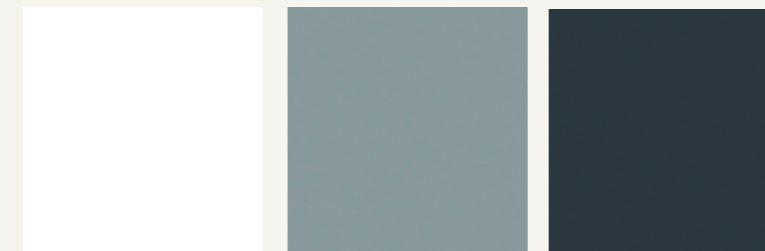

**White**  
Solid Core Laminate

**Grey**  
Solid Core Laminate

**Charcoal**  
Solid Core Laminate

# MFC

\* Only Urban Maple, Strata Oak, Black and White apply to Crate Divide



Black (Standard)  
MFC

White  
MFC

Strata Oak  
MFC

Urban Maple  
MFC

Autumn  
MFC

Beech  
MFC

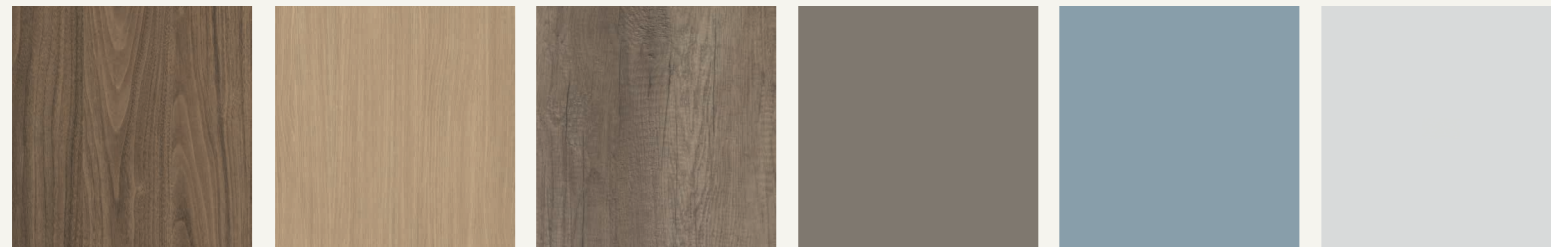

Carini Walnut  
MFC

Highland Oak  
MFC

Winter Oak  
MFC

Clay  
MFC

Denim  
MFC

Light Grey  
MFC

# Kvadrat Really Top



Cotton Blue  
Kvadrat Really Top

Cotton Cream  
Kvadrat Really Top

Cotton White  
Kvadrat Really Top

# Edge Stains



Clear on Ply  
Edge Stains

Clear on MDF  
Edge Stains

Solid Black  
Edge Stain

Solid White  
Edge Stain

# Edge Tapes

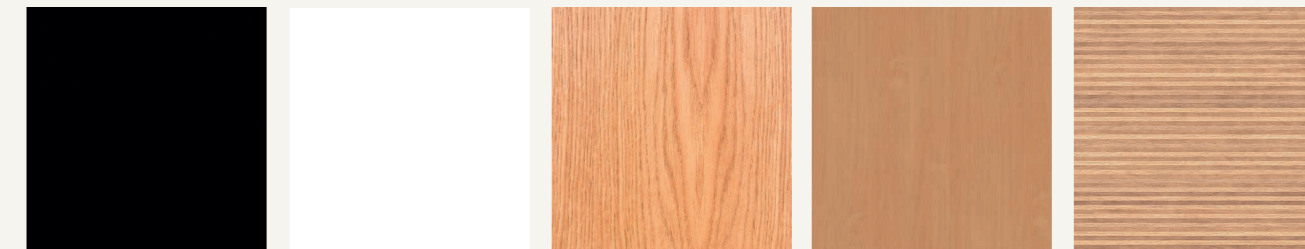

Black  
Edge Tape

White  
Edge Tape

Oak  
Edge Tape

Beech  
Edge Tape

Ply  
Edge Tape

# Edge Details

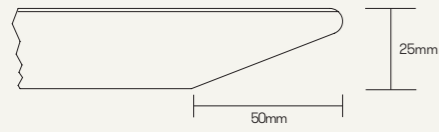

**Ref Group Number 37**  
25mm MDF core, specified laminate face & counterbalance with 50mm chamfered edge. The edge is clear finish as standard or can be stained.

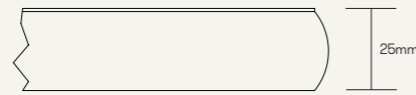

**Ref Group Number 11**  
25mm MDF core, specified laminate face & counterbalance with convex edge, as standard. The edge is clear finish as standard or can be stained.

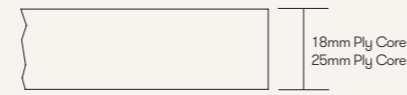

**Ref Group Number 33**  
18mm Ply core, specified laminate or linoleum face and counterbalanced with a flat edge or 25mm Ply core, specified laminate or linoleum face and counterbalanced with a flat edge.

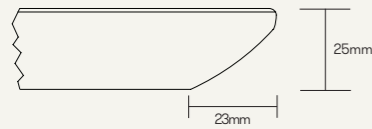

**Ref Group Number 28**  
25mm MDF core, specified laminate face & counterbalance with 23mm chamfered edge. The edge is clear finish as standard or can be stained.



**Ref Group Number 41**  
12mm solid surface - Design Range.

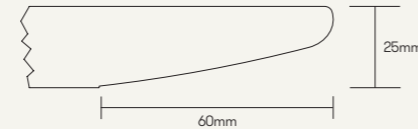

**Ref Group Number 38**  
25mm MDF core, specified laminate face & counterbalance with 60mm chamfered edge. The edge is clear finish as standard or can be stained.



**Ref Group Number 46**  
25mm MDF core, specified laminate face & counterbalance with 20mm chamfered edge. The edge is clear finish as standard or can be stained.

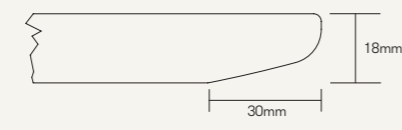

**Ref Group Number 43**  
18mm solid wood.

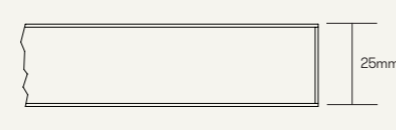

**Ref Group Number TE**  
Taped Edge.

# Outdoor Finishes

## Metal / Frame Finishes



**Basalt (Textured)**  
FineTex Finish

**Black (Texture)**  
FineTex Finish

**Blush**  
FineTex Finish

**Ivory**  
FineTex Finish

**Olive**  
FineTex Finish

**Pastel Green**  
FineTex Finish



**Sage (Textured)**  
FineTex Finish

**Teal**  
FineTex Finish

## Plastic / Shell Finishes

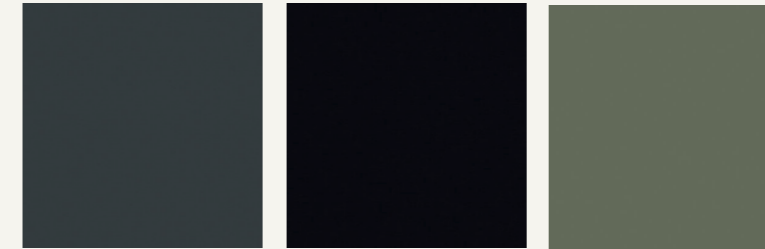

**Basalt**  
Plastic / Shell Finish

**Black / Back to Black**  
Plastic / Shell Finish

**Sage**  
Plastic / Shell Finish

## Solid Wood Finish

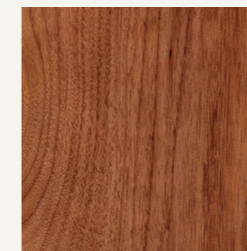

**Teak**  
Solid Wood Finish

## Solid Core Laminates



**Charcoal**  
Solid Core Laminate

**Grey**  
Solid Core Laminate

**White**  
Solid Core Laminate

# Ooty Seat Pad Upholstery



Melange Nap 951 Ooty Seat Pad  
Melange Nap 521 Ooty Seat Pad  
Melange Nap 711 Ooty Seat Pad  
Melange Nap 111 Ooty Seat Pad  
Melange Nap 271 Ooty Seat Pad  
Melange Nap 211 Ooty Seat Pad



Melange Nap 191 Ooty Seat Pad

# Crop Seat Pad Upholstery

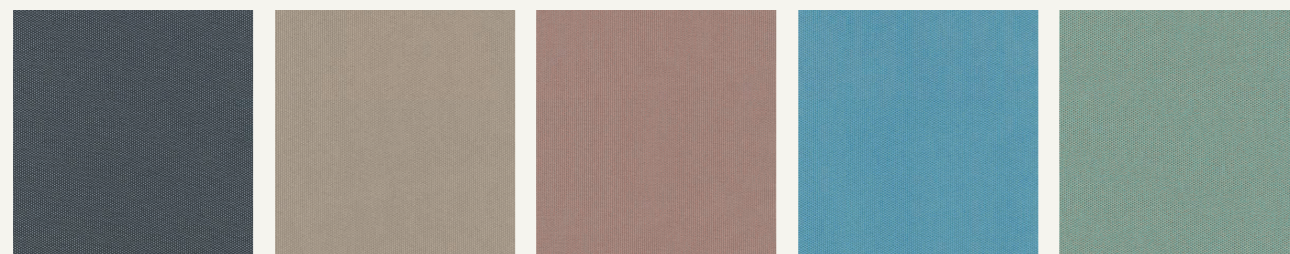

Kvadrat Patio 170 Crop Seat Pad  
Kvadrat Patio 230 Crop Seat Pad  
Kvadrat Patio 340 Crop Seat Pad  
Kvadrat Patio 740 Crop Seat Pad  
Kvadrat Patio 840 Crop Seat Pad

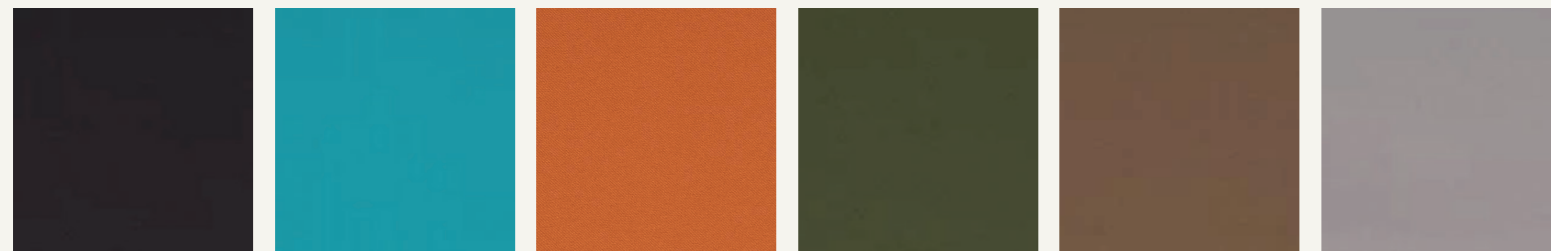

Agua Aura Ebony Crop Seat Pad  
Agua Aura Turquoise Crop Seat Pad  
Agua Aura Copper Seat Pad Upholstery  
Agua Aura Forest Crop Seat Pad  
Agua Aura Mink Crop Seat Pad  
Agua Aura Nimbus Crop Seat Pad

# Loose Cushion Edge Details

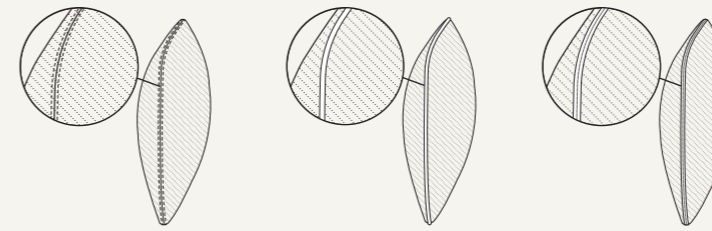

Twinned Cushion Edge Detail  
Piped Cushion Edge Detail  
Zipped Cushion Edge Detail

# Loose Cushion Face Details

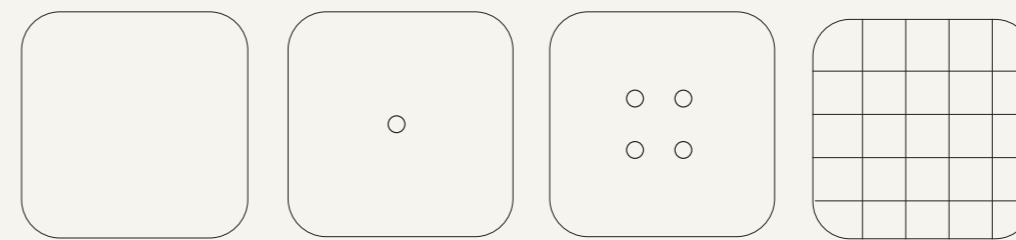

Plain Cushion Face Detail  
Single Button Cushion Face Detail  
Multi Button Cushion Face Detail  
Quilted Cushion Face Detail

# Tylus Synergy

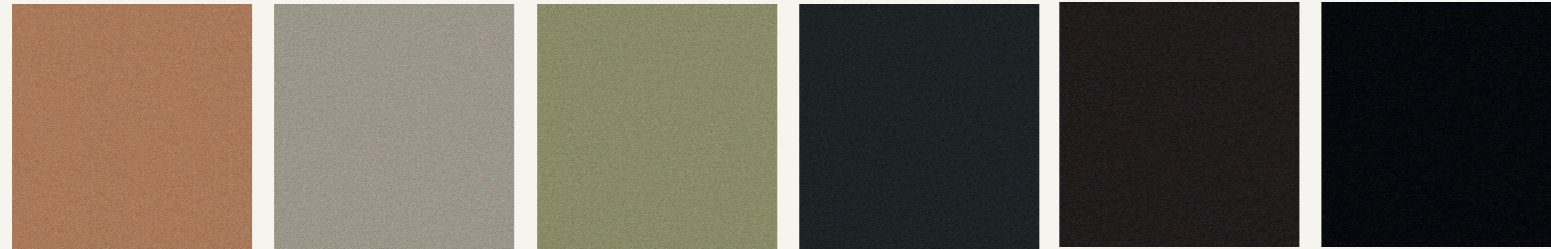

**Loop LDS18**  
Tylus Synergy

**Level LDS20**  
Tylus Synergy

**Bracket LDS23**  
Tylus Synergy

**Compound LDS25**  
Tylus Synergy

**Bridge LDS26**  
Tylus Synergy

**Seek LDS27**  
Tylus Synergy

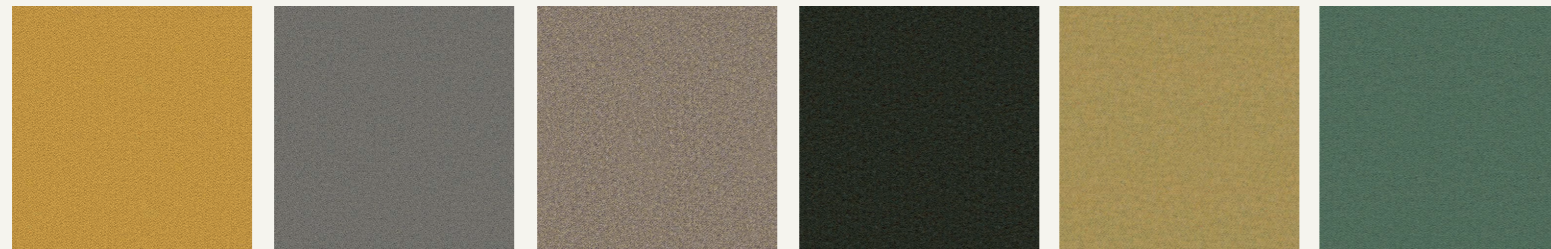

**Lateral LDS28**  
Tylus Synergy

**Pair LDS31**  
Tylus Synergy

**Affix LDS32**  
Tylus Synergy

**Couple LDS41**  
Tylus Synergy

**Summon LDS45**  
Tylus Synergy

**Append LDS49**  
Tylus Synergy

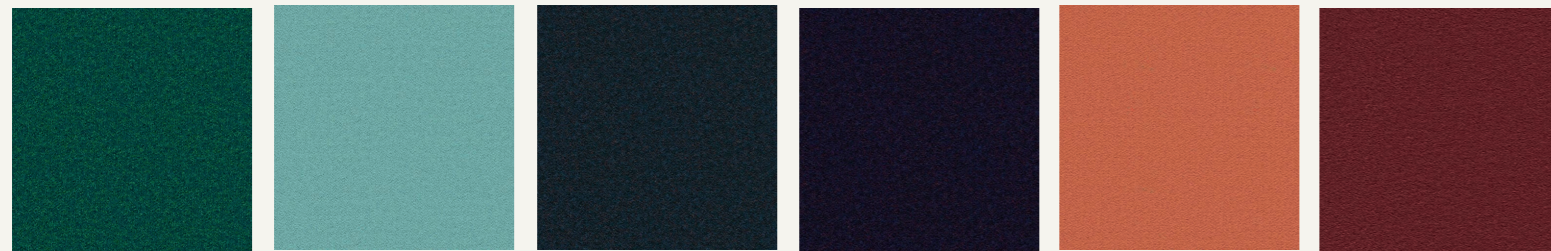

**League LDS50**  
Tylus Synergy

**Support LDS55**  
Tylus Synergy

**Accord LDS60**  
Tylus Synergy

**Assemble LDS61**  
Tylus Synergy

**Contribution LDS75**  
Tylus Synergy

**Amiable LDS79**  
Tylus Synergy

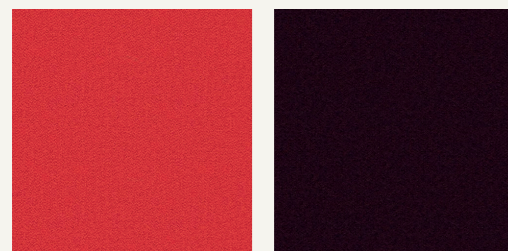

**Apt LDS80**  
Tylus Synergy

**Process LDS88**  
Tylus Synergy

# Quilting Designs

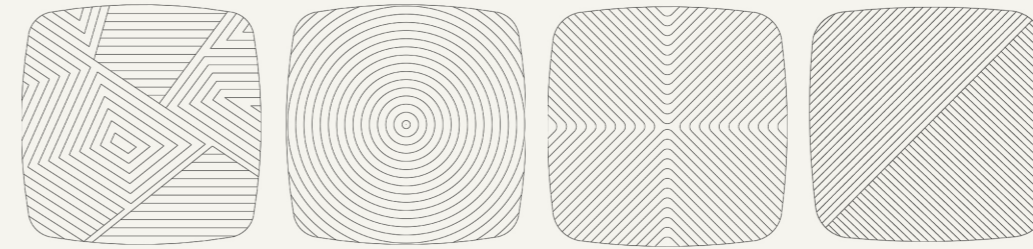

**Aztec**  
Quilting Design

**Echo**  
Quilting Design

**Flow**  
Quilting Design

**Lines**  
Quilting Design

# Saddle Leather Handle

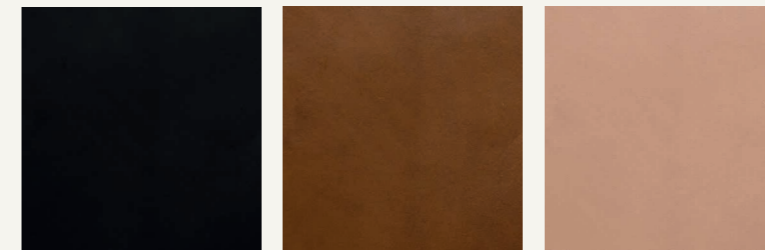

**Black**  
Saddle Leather Handle

**Dark Tan**  
Saddle Leather Handle

**Natural**  
Saddle Leather Handle

# Zipper and Tape Finishes

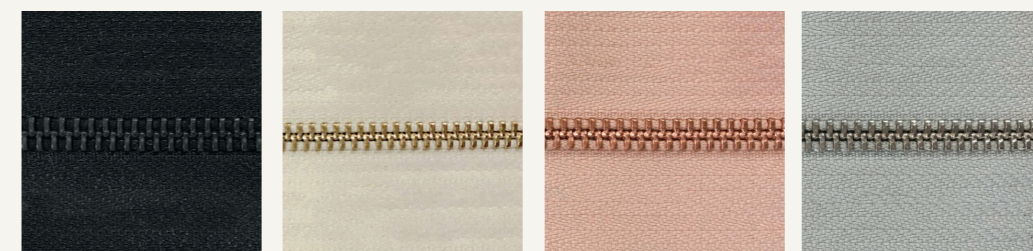

**Black Zipper with Black Tape**  
Zipper and Tape

**Gold Zipper with Ivory Tape**  
Zipper and Tape

**Rose Gold Zipper with Peach Tape**  
Zipper and Tape

**Silver Zipper with Grey Tape**  
Zipper and Tape





a whole world of colour

### Finish Boxes and Sample Service

Our new Global Colour Palette is now available to order to order your finish and fabric samples, Finish Box and Finish Cards please contact your representative, or email:

[finishes@thesenatorgroup.com](mailto:finishes@thesenatorgroup.com)

## Configure your designs

With hundreds of products, fabrics and finish options available Allermuir makes specifying and styling simple. We've even added the option to download custom renders straight to your device. Simply go to every product page at Allermuir.com to configure your product.

Hit 'view in your room' to see every product in the Allermuir range, configured the way you want it, directly in your lounge, office, reception, hotel lobby or cafeteria by the power of VR, all at the touch of a button.

Simply go to any product page on [allermuir.com](http://allermuir.com) to configure your product.

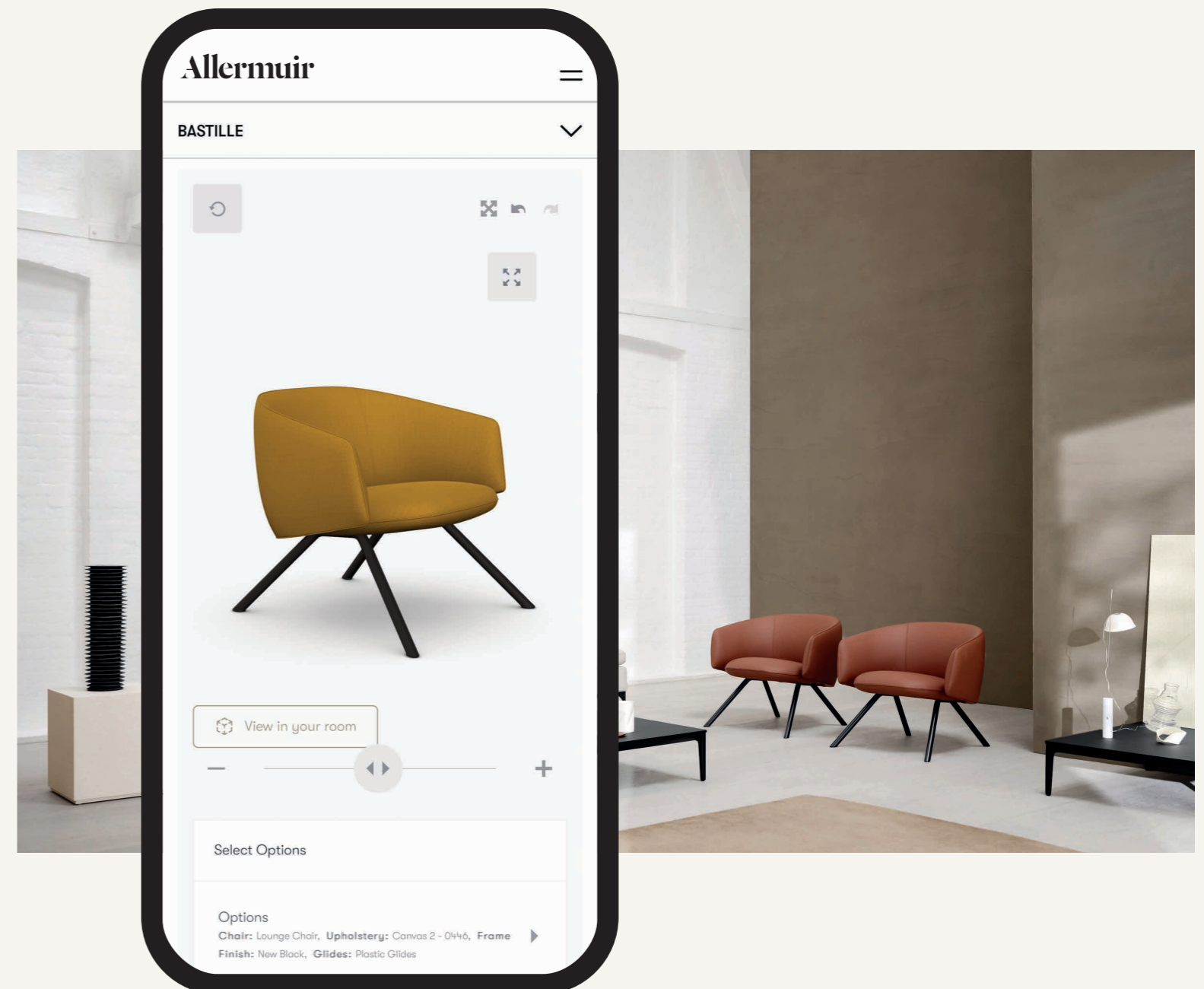

**Global Headquarters**

Altham Business Park  
Accrington, Lancashire  
BB5 5YE  
United Kingdom

**Corporate Headquarters**

4111 N. Jerome Road  
Maumee, OH  
43537  
United States

**Hong Kong**

Suites 2508-2509,  
K11 Aterlier,  
728 Kings Road,  
Quarry Bay  
Hong Kong

194

195

**London**

Back Hill  
Farringdon  
London EC1R 5EN  
United Kingdom

**Chicago**

222 Merchandise Mart  
Floor 11, Suite 1112  
Chicago, IL  
60654  
United States

**Bengaluru**

No. 295 & 296, 3rd Floor  
100 Feet Road  
Indiranagar  
Bengaluru 560038  
India

**Birmingham**

Sovereign Hall  
Frederick Street  
Birmingham B1 3HE  
United Kingdom

**New York**

3 East 28th St, 9th Floor  
New York, NY  
10016  
United States

**Join the conversation:**

@allermuir / allermuir.com

**Allermuir** *Part of* **The Senator Group**

The Senator Group is the glue that unites all the individual product brands together with exceptional people, service, and unrivalled manufacturing capability.

The Senator Group and its house of brands has grown into one of the largest office furniture manufacturers in the world, remaining an independent, family-owned business meaning attention to detail, integrity, investment in people, and passion for design.

Rather than outsource manufacturing and face the inevitable compromises of oversight and agility that entails, we've continued to invest in highly capable and adaptable production technology. Trusting everything to our own skilled people and keeping our own technology cutting edge is The Senator Group's secret to quality.

[www.thesenatorgroup.com](http://www.thesenatorgroup.com)

